

Analog Set Multifunction Timers

H3DS Series



To view data sheets, click on any link below:

[H3DS](#) - Standard Timer

[H3DS-F](#) - Twin Timer

[H3DS-G](#) - Star-Delta Timer

[H3DS-X](#) - Solid State Two-Wire Timer

Analog Set Multi-function, Ultra-Slim 17.5 mm Timers for Track Mounting

- Wide AC/DC power supply range (24 to 230 VAC/24 to 48 VDC) minimizes inventory
- Smart Dial/Selector-Locking Mechanism prevents the dials and selectors on the timer's front panel from being operated without authorization (lock can only be unlocked and locked with an optional pen-type Lock Key)
- Eight operating modes (H3DS-M) and four operating modes (H3DS-S) to cover a wide range of applications
- Offers wide time setting range of 0.10 s to 120 h
- Finger protection terminal block prevents shock, meets VDE0106/P100
- High immunity to inverter noise



Ordering Information

Input	Operating mode	Part number	
		Screw terminal	Cage clamp
Voltage input	8 modes	H3DS-ML-AC24-230/DC24-48	H3DS-MLC-AC24-230/DC24-48
No-input available	4 modes	H3DS-SL-AC24-230/DC24-48	H3DS-SLC-AC24-230/DC24-48
	Single mode	H3DS-AL-AC24-230/DC24-48	H3DS-ALC-AC24-230/DC24-48

Model Number Legend

H3DS - L
 1 2 3

1. M: Multi-function type (8 modes)
 S: Standard type (4 modes)
 A: Single-function type
2. L: Smart lock mechanism
3. None: Screw terminal type
 C: Cage clamp terminal type

Accessories (Order Separately)

Description		Part number
Lock Key		Y92S-38
Mounting Track	50 cm (l) x 7.3 mm (t)	PFP-50N
	1 m (l) x 7.3 mm (t)	PFP-100N
	1 m (l) x 16 mm (t)	PFP-100N2
End Plate		PFP-M
Spacer		PFP-S

Specifications

■ General

Item	H3DS-ML□	H3DS-SL□	H3DS-AL□
Operating mode	A: ON-delay (Signal or Power) B: Repeat-cycle OFF-start (Signal or Power) B2: Repeat-cycle ON-start (Signal or Power) C: Signal ON/OFF-delay D: Signal OFF-delay E: Interval (Signal or Power) G: Signal ON/OFF-delay J: One-shot (Signal or Power)	A: ON-delay B2: Repeat-cycle ON-start E: Interval J: One-shot	A: ON-delay (fixed)
Input type	Voltage input	---	
Output type	Relay: SPDT		
External connections	Screw terminal, cage clamp terminal		
Terminal block	Screw terminal type: Clamps two 2.5-mm ² max. bar terminals without sleeves. Cage clamp terminal type: Clamps two 1.5-mm ² max. bar terminals without sleeves.		
Terminal screw tightening torque	0.98 N • m max.		
Mounting method	DIN track mounting (See Note.)		
Attachment	Nameplate label		
Approved standards	UL508, CSA C22.2 No. 14 Conforms to EN61812-1, IEC60664-1 (VDE0110) 4 kV/2, VDE0106/P100 Output category according to IEC60947-5-1 (AC-13; 250 V 5 A/AC-14; 250 V 1 A/AC-15; 250 V 1 A/DC-13; 30 V 0.1 A/DC-14; 30 V 0.05 A)		

Note: Can be mounted to 35-mm DIN Track with a plate thickness of 1 to 2.5 mm.

■ Time Ranges

Time scale display	Time range
0.1 s	0.1 to 1.2 s
1 s	1 to 12 s
0.1 m	0.1 to 1.2 min
1 m	1 to 12 min
0.1 h	0.1 to 1.2 h
1 h	1 to 12 h
10 h	10 to 120 h

Note: When the time setting dial is set to "0" for any time scale, the output will operate instantaneously.

■ Ratings

Rated supply voltage (See Notes 1 and 2.)	24 to 230 VAC (50/60 Hz)/24 to 48 VDC
Operating voltage range	85% to 110% of rated supply voltage
Power reset	Minimum power-off time: 0.1 s
Reset voltage	2.4 VAC/DC max.
Power consumption (See Note 3.)	AC: 32 VA max./3.0 W max. (typical: 30 VA/2.7 W) at 230 VAC 14 VA max./2.2 W max. (typical: 13 VA/2.1 W) at 100 to 120 VAC DC: 0.7 W max. (typical: 0.6 W) at 24 VDC 1.4 W max. (typical: 1.3 W) at 48 VDC
Voltage input	Max. permissible capacitance between inputs lines (terminals B1 and A2): 2,000 pF Load connectable in parallel with inputs (terminals B1 and A1). H-level: 20.4 to 253 VAC/20.4 to 52.8 VDC L-level: 0 to 2.4 VAC/DC
Control output	Contact output: 5 A at 250 VAC with resistive load ($\cos\phi = 1$); 5 A at 30 VDC with resistive load ($\cos\phi = 1$)
Ambient temperature	Operating: -10°C to 55°C (14°F to 131°F) with no icing Storage: -25°C to 65°C (-13°F to 149°F) with no icing
Ambient humidity	Operating: 35% to 85%

Note: 1. DC ripple rate: 20% max.

2. Since an inrush current of 0.4 A will occur when using the power supply voltage at 24 VDC, pay careful attention when turning on or off the power supply to the Timer with a solid-state output such as a sensor.

3. The power consumption is for mode A after the Timer counts the time-up time and for the AC input at 50 Hz. The power consumption of the H3DS-ML includes the input circuit with the B1 and A1 terminals short-circuited.

■ Characteristics

Accuracy of operating time	±1% max. of FS (±1% ±10 ms max. at 1.2-s range)
Setting error	±10% ±50 ms max. of FS
Signal input time	50 ms min.
Influence of voltage	±0.7% max. of FS (±0.7% ±10 ms max. at 1.2-s range)
Influence of temperature	±2% max. of FS (±2% ±10 ms max. at 1.2-s range)
Insulation resistance	100 MΩ min. at 500 VDC
Dielectric strength	Between current-carrying metal parts and exposed non-current-carrying metal parts: 2,000 VAC for 1 min. Between control output terminals and operating circuit: 2,000 VAC for 1 min. Between contacts not located next to each other: 1,000 VAC for 1 min.
Vibration resistance	Malfunction: 0.5-mm single amplitude at 10 to 55 Hz Destruction: 0.75-mm single amplitude at 10 to 55 Hz
Shock resistance	Malfunction: 100 m/s ² 3 times each in 6 directions Destruction: 1,000 m/s ² 3 times each in 6 directions
Impulse withstand voltage	3 kV (between power terminals) 4.5 kV (between current-carrying metal parts and exposed non-current-carrying metal parts)
Noise immunity	Square-wave noise generated by noise simulator (pulse width: 100 ns/1 μs, 1-ns rise) ±1.5 kV
Static immunity	Malfunction: 4 kV Destruction: 8 kV
Life expectancy	Mechanical: 10 million operations min. (under no load at 1,800 operations/h) Electrical: 100,000 operations min. (5 A at 250 VAC, resistive load at 360 operations/h) See Note.
EMC	(EMI) Emission Enclosure: EN55011 Group 1 class B Emission AC Mains: EN55011 Group 1 class B (EMS) Immunity ESD: EN61000-4-2: 6 kV contact discharge (level 3) 8 kV air discharge (level 3) Immunity RF-interference from AM Radio Waves: EN61000-4-3: 10 V/m (80 MHz to 1 GHz) (level 3) Immunity Burst: EN61000-4-4: 2 kV power port and output port (level 3) 1 kV control port with capacitive clamp (level 3) Immunity Surge: EN61000-4-5: 2 kV common mode (level 3) 1 kV differential mode (level 3)
Case color	Light gray (5Y7/1)
Degree of protection	IP30 (Terminal block: IP20)
Weight	Approx. 70 g

Note: For reference:
 A maximum current of 0.15 A can be switched at 125 VDC (cosφ =1).
 A maximum current of 0.1 A can be switched if L/R is 7 ms.
 In both cases, a life of 100,000 operations can be expected.
 The minimum applicable load is 10 mA at 5 VDC (failure level: P).

Nomenclature

H3DS-ML□ /-SL□

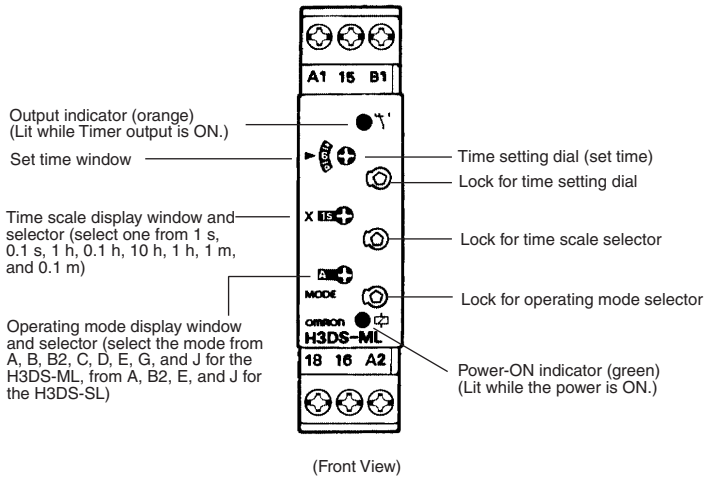

H3DS-MLC/-SLC

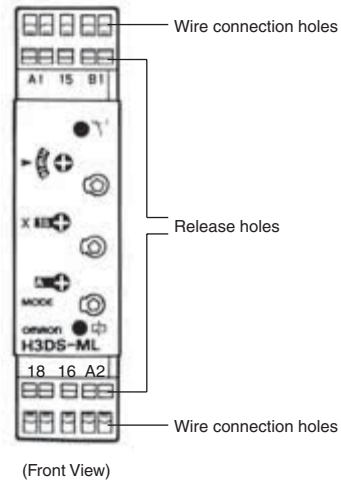

H3DS-AL□

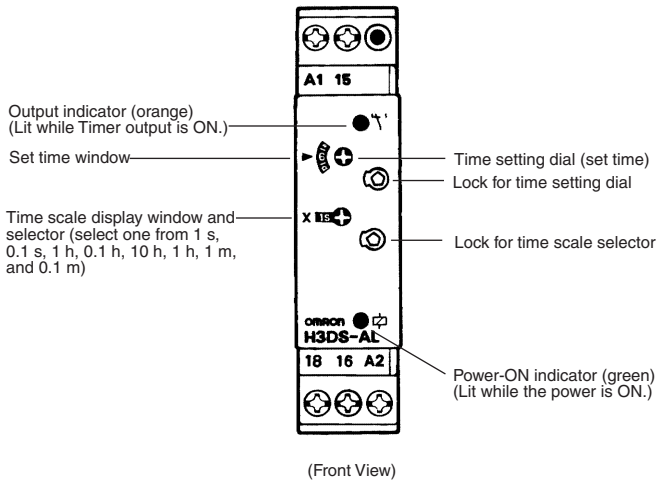

H3DS-ALC

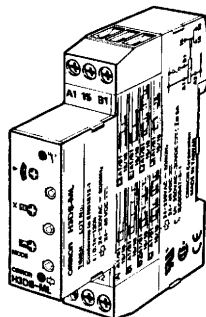
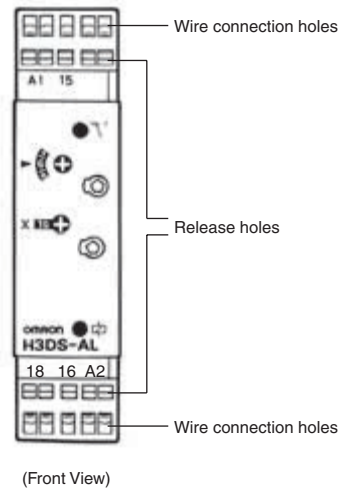

Attach the enclosed label here as a nameplate.
(The label is attached to the Timer's DIN Track hook section at the time of shipment.)

Operation

■ Block Diagram

H3DS-ML□

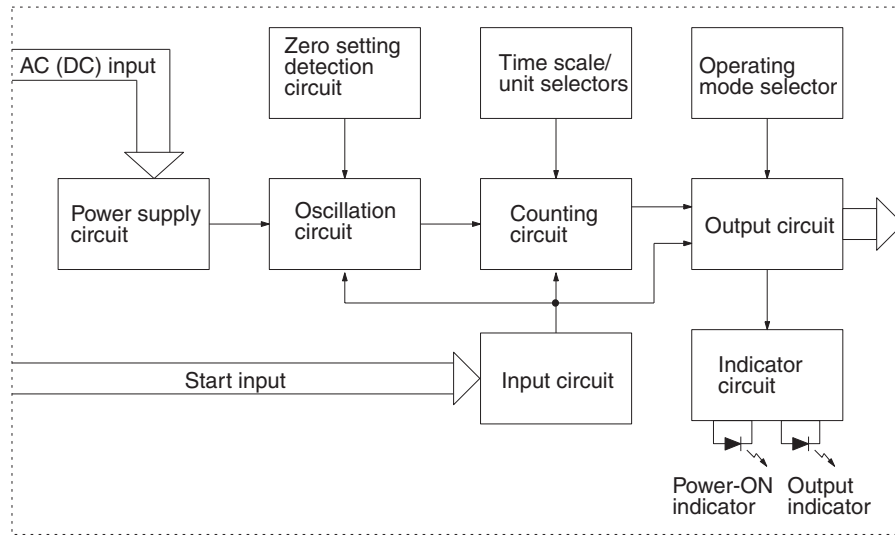

H3DS-SL□/-AL□

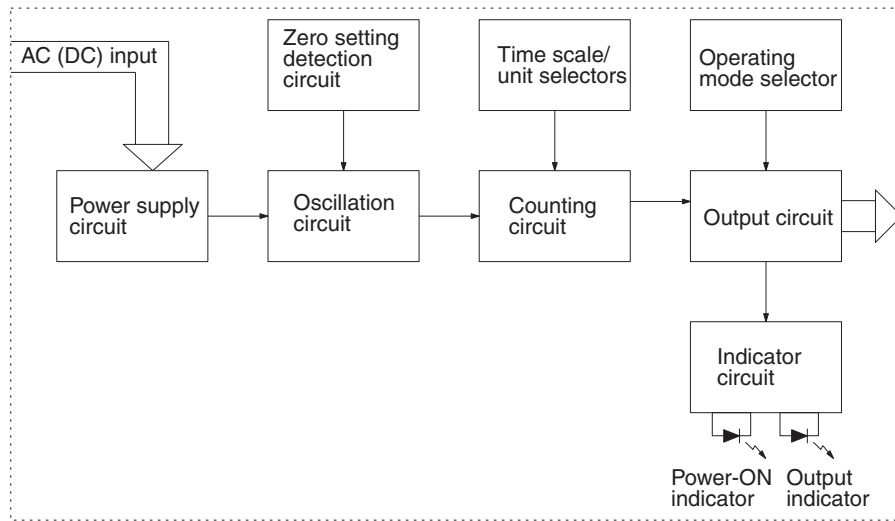

■ I/O Functions

Item		H3DS-ML□	H3DS-SL□/-AL□
Input	Start	Starts operation.	No input is available.
Output	Control output	Outputs are turned ON according to designated output mode when preset value is reached.	Outputs are turned ON according to designated output mode when preset value is reached.

■ Basic Operation

Setting of Selector

The selectors can be turned clockwise and counterclockwise to select the desired time scale or operating mode.

Each selector has a snap mechanism that secures the selector at a given position. Set the selector at a position where it is secured. Do not set it midway between two secure positions, or a malfunction could result from improper setting.

Selection of Operating Mode (except for H3DS-AL)

The H3DS-ML/-SL can be set to any one of the operating modes A to J. Turn the operating mode selector with a screwdriver until the desired operating mode appears in the operating mode display window.

H3DS-ML (8 modes): A, B, B2, C, D, E, G, J
(In order of appearance)

H3DS-SL (4 modes): A, E, B2, J, E, J, J
(In order of appearance)

Note: Letters that appear more than once indicate exactly the same operating mode.

Selection of Time Scale

The time scale is selected by turning the time scale selector. The time scales will appear (in the time scale display window to the left of the selector) in the order shown here:

1 s, 0.1 s, 1 h, 0.1 h, 10 h, 1 h, 1 m, 0.1 m.

Note: The time scale "1h" appears twice. Both instances indicate exactly the same time scale.

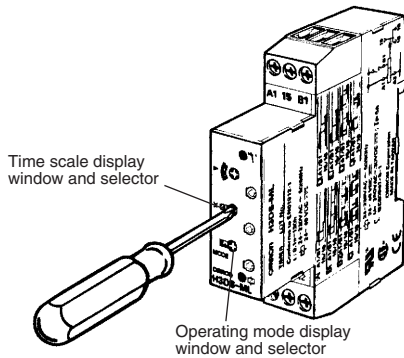

Locking/Unlocking of Selectors and Time Setting Dial

The time setting dial, time scale selector, and operating mode selector can be locked using the Y92S-38 Lock Key, a special pen-type tool that is sold separately. To lock the dial or selectors, insert the Lock Key in the keyhole to the lower right of the dial or selector and turn it clockwise until the dial or selector is completely covered with the red cover. To unlock, turn the Lock Key in the opposite direction.

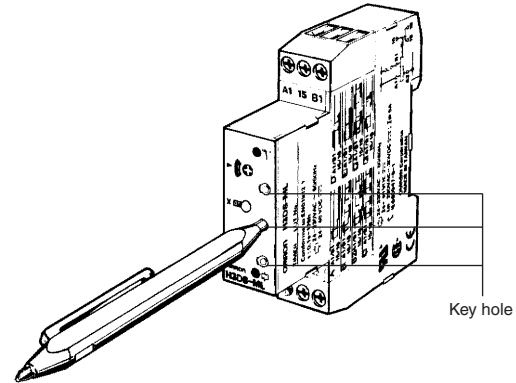

■ Timing Chart

- Note:** 1. The minimum power reset time is 0.1 s and the minimum signal input time is 0.05 s.
 2. The letter "t" in the timing charts stands for the set time and "t-a" means that the period is less than the time set.

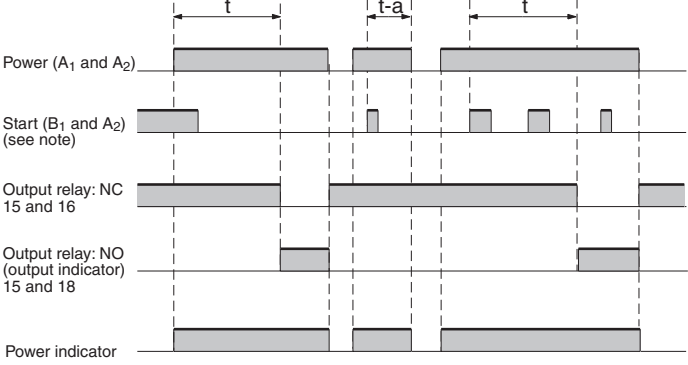
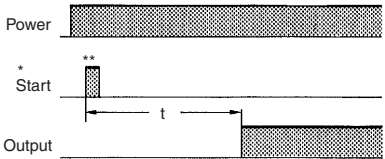
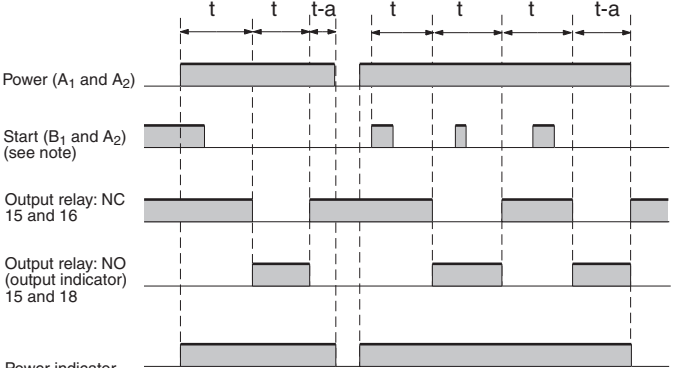
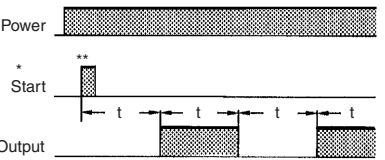
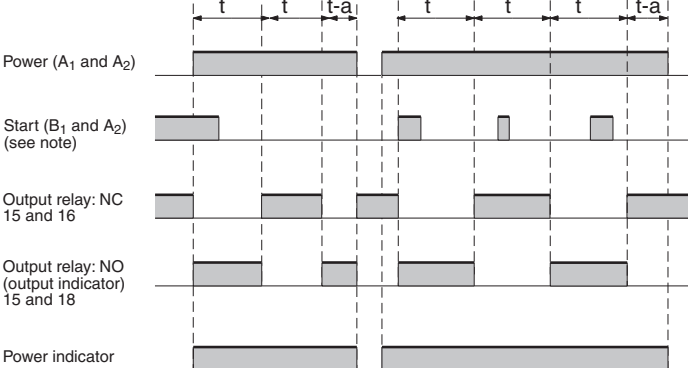
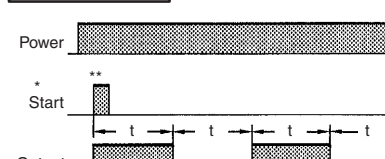
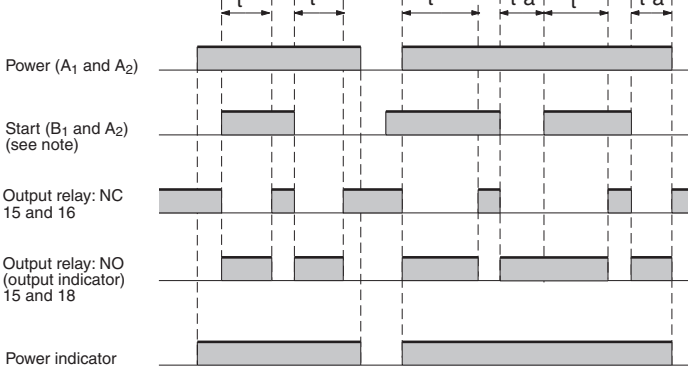
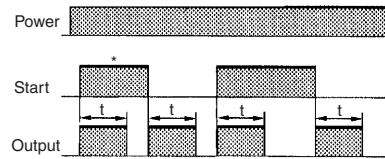
Operating mode	Timing chart
A: ON-delay	 <div style="float: right; border: 1px solid black; padding: 5px; margin-top: 10px;"> Basic operation  <p>* For power-on operation, impose voltage to the Start input. The Timer starts operating at the moment the power is turned on. ** Start input is invalid while the Timer is in operation.</p> </div>
B: Repeat-cycle OFF-start	 <div style="float: right; border: 1px solid black; padding: 5px; margin-top: 10px;"> Basic operation  <p>* For power-on operation, impose voltage to the Start input. The Timer starts operating at the moment the power is turned on. ** Start input is invalid while the Timer is in operation.</p> </div>
B2: Repeat-cycle ON-start	 <div style="float: right; border: 1px solid black; padding: 5px; margin-top: 10px;"> Basic operation  <p>* For power-on operation, impose voltage to the Start input. The Timer starts operating at the moment the power is turned on. ** Start input is invalid while the Timer is in operation.</p> </div>
C: Signal ON/OFF-delay	 <div style="float: right; border: 1px solid black; padding: 5px; margin-top: 10px;"> Basic operation  <p>* Start input is invalid while the Timer is in operation.</p> </div>

Note: The start input of the H3DS-ML□ model is activated by applying a voltage to B1 and A2 terminals. The voltage can be applied by turning on the contact between B1 and A1. Refer to *Terminal Arrangement*.

(This chart continues on the following page.)

Timing Chart - continued from the previous page.

- Note:** 1. The minimum power reset time is 0.1 s and the minimum signal input time is 0.05 s.
 2. The letter "t" in the timing charts stands for the set time and "t-a" means that the period is less than the time set.

Operating mode	Timing chart
<p>D: Signal OFF-delay</p>	<p>Basic operation</p> <p>* Start input is valid and re-triggerable while the Timer is in operation.</p>
<p>E: Interval</p>	<p>Basic operation</p> <p>* For power-on operation, impose voltage to the Start input. The Timer starts operating at the moment the power is turned on. ** Start input is valid and re-triggerable while the Timer is in operation.</p>
<p>G: Signal ON/OFF-delay</p>	<p>Basic operation</p> <p>* Start input is valid and re-triggerable while the Timer is in operation.</p>
<p>J: One-shot output (ON delay)</p>	<p>Basic operation</p> <p>* For power-on operation, impose voltage to the Start input. The Timer starts operating at the moment the power is turned on. ** Start input is valid and re-triggerable while the Timer is in operation.</p>

Note: The start input of the H3DS-ML□ model is activated by applying a voltage to B1 and A2 terminals. The voltage can be applied by turning on the contact between B1 and A1 (Refer to *Terminal Arrangement*).

Dimensions

Unit: mm (inch)

■ H3DS-ML/-SL/-AL

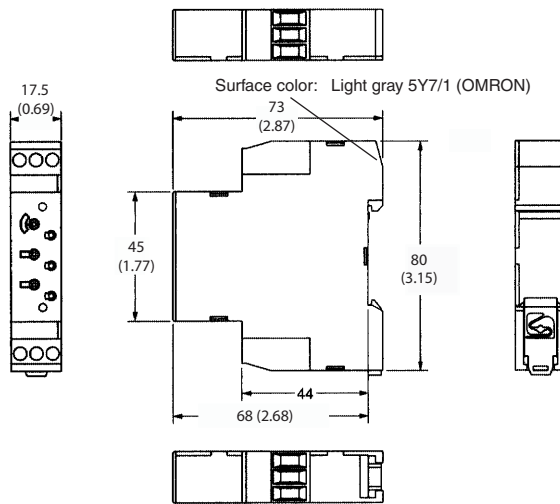
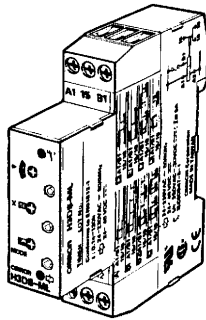

■ H3DS-MLC/-SLC/-ALC

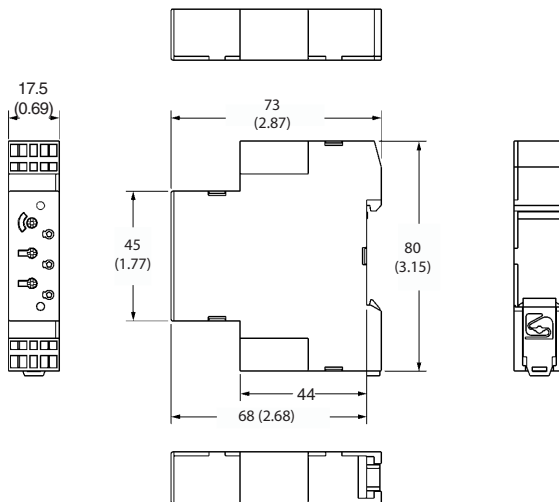
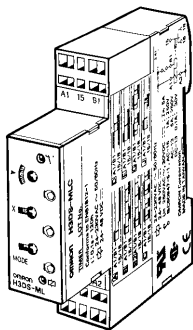

Accessories (Order Separately)

Unit: mm (inch)

■ Lock Key Y92S-38

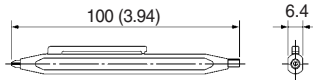
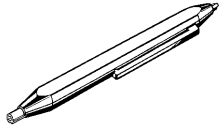

■ Mounting Track

PFP-100N, PFP-50N

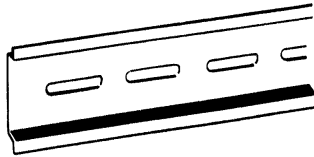

PFP-100N2

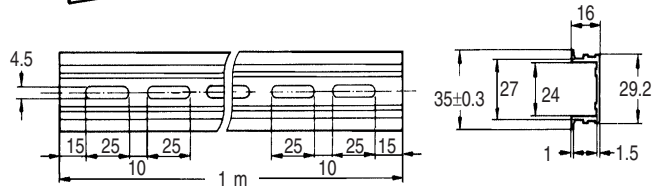
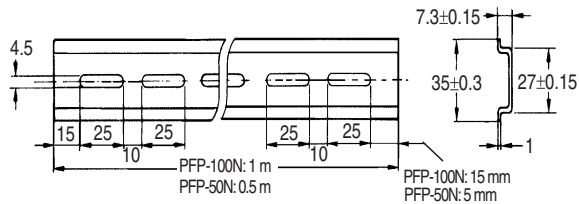
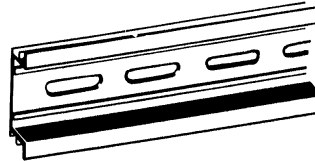

■ End Plate

PFP-M

■ Spacer

PFP-S

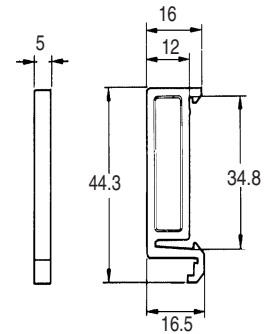
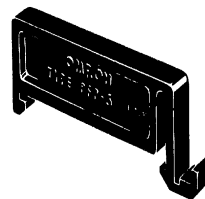
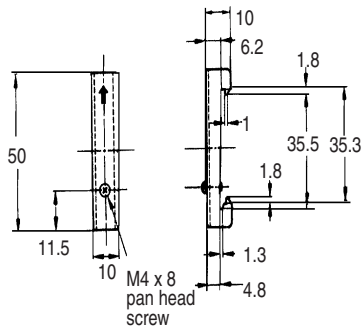
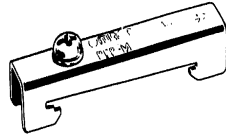

Installation

Terminal Arrangement

H3DS-MLC

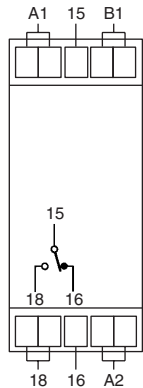

H3DS-ML

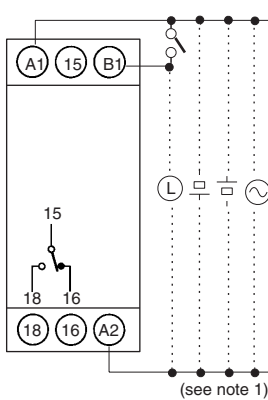

H3DS-SLC/-ALC

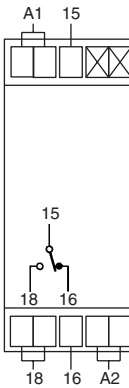

H3DS-SL/-AL

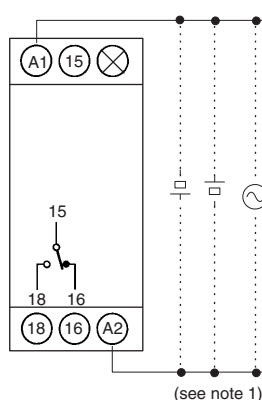

Note: 1. DC supply voltage does not require the designation of polarity.

2. The contact symbol for the H3DS is indicated with  because it offers multiple operating modes and is different from the delayed contact for conventional timers.

Input Connections

The inputs of the H3DS-ML□ are voltage (voltage imposition or open) inputs.

No-contact Input

(Connection to PNP output sensor.)

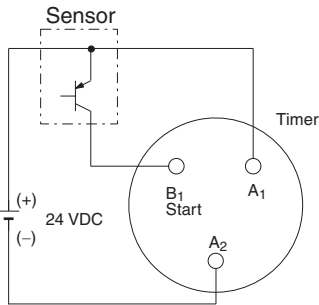

Operates with PNP transistor ON

No-contact Input

(Connection to NPN output sensor.)

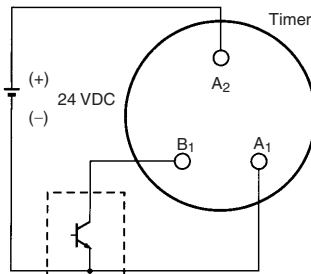

Operates with NPN transistor ON

Contact Input

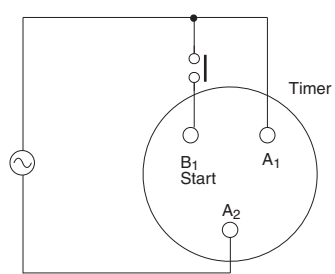

Operates with relay ON

Voltage Input Signal Levels

No-contact input	1. Transistor ON Residual voltage: 1 V max. (Voltage between terminals B ₁ and A ₂ must be more than the rated "H-level" voltage (20.4 VDC min.).)
	2. Transistor OFF Leakage current: 0.01 mA max. (Voltage between terminals B ₁ and A ₂ must be less than the rated "L-level" voltage (2.4 VDC max.).)
Contact input	Use contacts that can adequately switch 0.1 mA at each voltage to be imposed. (When the contacts are ON or OFF, voltage between terminals B ₁ and A ₂ must be within the following ranges: When contacts are ON: 20.4 to 253 VAC/20.4 to 52.8 VDC When contacts are OFF: 0 to 2.4 VAC/DC)

Tools

A flat-blade screwdriver should be used to install the cables.

Applicable Screwdriver

- Flat-blade, Parallel-tip, 2.5 mm diameter

- Flat-blade, Parallel-tip



- Flat-blade, Flared-tip

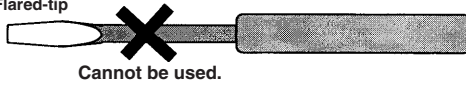

Examples: FACOM AEF.2.5 × 75E
VESSEL No. 9900-(-)2.5 × 75
WAGO 210-119
WIHA 260/2.5 × 40

Applicable Wires

Applicable Wire Sizes

0.2 to 1.5 mm², AWG24 to AWG16

Applicable Wire Type

Solid wires, stranded wires, flexible wires, or wires with ferrules can be used.

(See note 1) $1.8 \leq \text{Diameter } D \text{ (mm)} \leq 3.0$ (See Note 2.)

Conductor diameter d (mm) or length of sides a and b (mm) ≤ 1.6

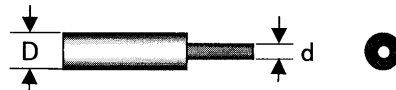

Wires with Ferrules



- Note:**
1. If the overall diameter of the wire is less than 1.8 mm, do not insert the wire past the conductor. Refer to the following diagrams.
 2. If the overall diameter of the wire is over 2.8 mm, it will be difficult to use double wiring.



Wiring

Use wires of the applicable sizes specified above. The length of the exposed conductor should be 6 to 7 mm.

Fig. 1 Exposed Conductor Length

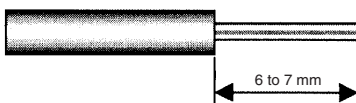

Use the following procedure:

1. Insert the specified screwdriver into the release hole located beside the wire connection hole where the wire is to be inserted.

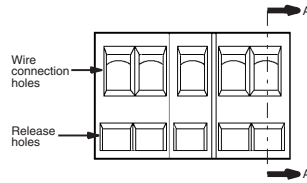

Fig. 2 Wire Connection Holes and Release Holes

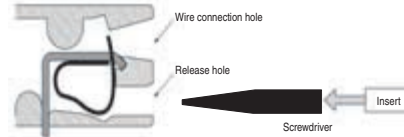
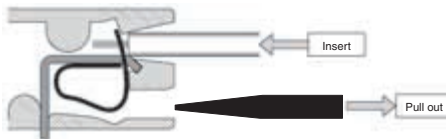

Fig. 3 Section A-A of Fig. 2

2. Insert the exposed conductor into the wire connection hole.



3. Pull out the screwdriver.



Wiring Precautions

Always insert the screwdriver straight into the hole, never at an angle. The clamp spring may bend if the screwdriver is not straight.

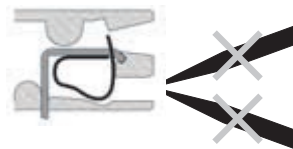

Do not move the screwdriver side to side in the clamp hole. The clamp spring may bend if the screwdriver is moved sideways.



Precautions

■ Setting Changes

⚠ WARNING

Do not change the time scale or operating mode while the Timer is in operation, or malfunction could result.

■ Power Supplies

The H3DS Series has a transformerless power supply system. Touching the input terminal while power is being supplied can cause you to get an electrical shock.

Use the bar terminal for wiring the H3DS. Using a stranded-wire terminal may cause a short-circuit due to a stray wire entering into the Timer.

Both AC and DC power supplies can be connected to the power input terminals without regard to polarity.

A DC power supply can be connected if its ripple factor is 20% or less and the mean voltage is within the rated operating voltage range of the Timer.

Make sure that the voltage is applied within the specified range, or the internal elements of the Timer may be damaged.

Connect the power supply voltage through a relay or switch in such a way that the voltage reaches a fixed value at once, or the Timer may not be reset or a timer error could result.

For the power supply of an input device of the H3DS-ML□, use an isolating transformer where the primary and secondary windings are mutually isolated, and the secondary winding is not grounded.

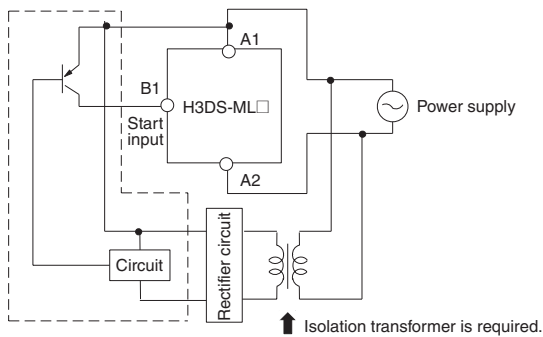

■ Installation

If the load current is continuously being supplied to the Timer for a long period of time, be sure to provide the mounting clearance as shown in the figure below. If used under conditions other than those specified below, the life of internal components may be shortened due to an excessive rise in the internal temperature.

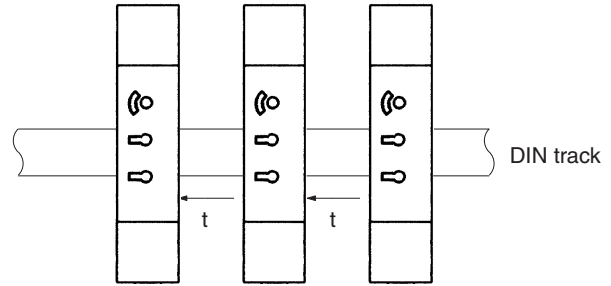

t: Mounting clearance (mm)

Switching Current vs. Ambient temperature (When Mounting Two or More H3DS Units Side-by-Side)

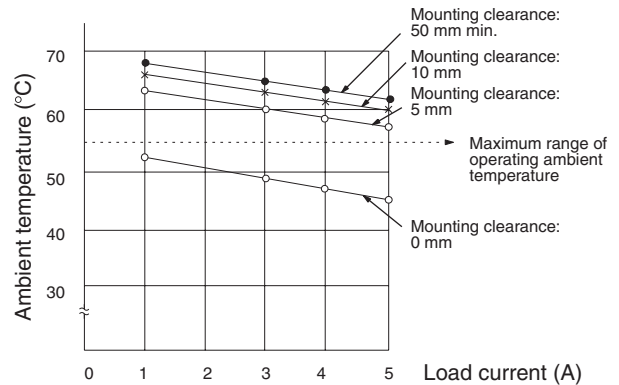

(Measurement Condition: Input voltage of 230 VAC)

■ Input/Output

Relationship between Input and Power Supply Circuits (H3DS-ML□)

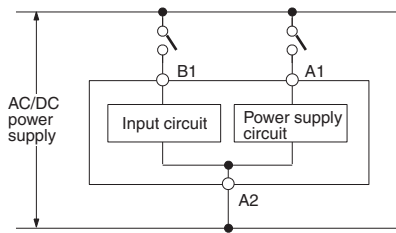

Since the input circuit and the power supply circuit are configured independently, the input circuit can be turned on or off regardless of the on/off state of the power supply.

It must be noted that a voltage equivalent to the power supply voltage is applied to the input circuit.

When connecting a relay or a transistor as an external signal input device, pay attention to the following points to prevent short-circuiting due to a sneak current to the transformerless power supply.

If a relay or transistor is connected to two or more Timers, the input terminals of those Timers must be wired properly so that they will not be different in phase or the terminals will be short-circuited to one another (refer to the figures below).

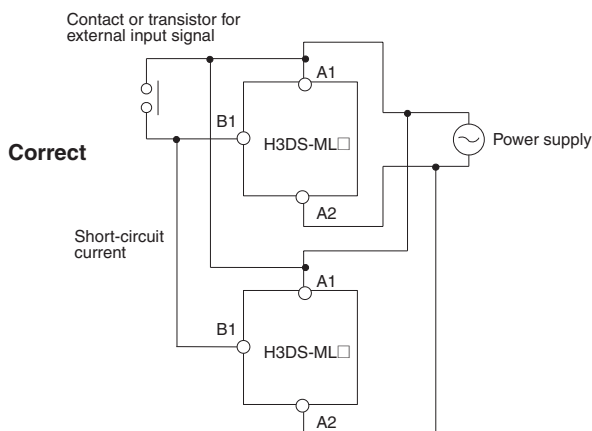
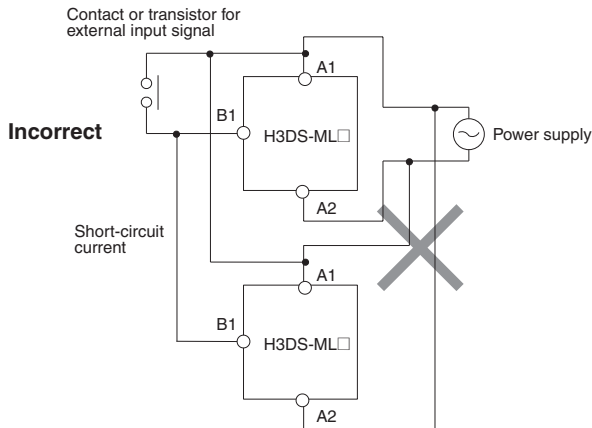

The H3DS Series is provided with a transformerless power supply system.

■ Precautions for EN61812-1 Conformance

The H3DS as a built-in timer conforms to EN61812-1 provided that the following conditions are satisfied:

The output section of the H3DS is provided only with basic isolation. To ensure reinforced isolation required by the EN61812-1, provide supplementary basic isolation on the load side connected to the output.

The H3DS itself is designed according to the following:

- Overvoltage category III
- Pollution degree 2

On the above basis:

Operation parts on the front and bottom: Reinforced isolation
 –With clearance of 5.5 mm and creepage distance of 5.5 mm at 230 VAC

Output: Basic isolation

–With clearance of 3 mm and creepage distance of 3 mm at 230 VAC

■ Environment

When using the Timer in an area with excess electrical noise, separate the Timer, wiring, and the equipment which generates the input signals as far as possible from the noise sources. Shield the input signal wiring to prevent electrical interference.

Organic solvents (such as paint thinner), as well as very acidic or basic solutions, can damage the outer casing of the Timer.

Do not use the Timer in places where it is exposed to dust, corrosive gas, or direct sunlight.

When storing the Timer, make sure that the ambient temperature and humidity are within the rated values. Leave the Timer at room temperature for at least three hours before using the Timer if it has been stored at an ambient temperature of -10°C or below.

■ Voltage Withstand Test

If the Timer is mounted on a control board, remove the Timer from the control board or short-circuit the circuitry of the power board before carrying out a voltage withstand test between the electrical circuitry and non-current-carrying metal part of the Timer, in order to prevent the internal circuitry of the Timer from damage.

ALL DIMENSIONS SHOWN ARE IN MILLIMETERS.

To convert millimeters into inches, multiply by 0.03937. To convert grams into ounces, multiply by 0.03527.

OMRON**OMRON ELECTRONICS LLC**

One East Commerce Drive
Schaumburg, IL 60173

1-800-55-OMRON**OMRON ON-LINE**

Global - <http://www.omron.com>
USA - <http://www.omron.com/oei>
Canada - <http://www.omron.com/oci>

OMRON CANADA, INC.

885 Milner Avenue
Scarborough, Ontario M1B 5V8

416-286-6465

17.5 mm Twin Timer Designed For Track Mounting

- Wide AC/DC power supply range, 24 to 230 VAC/24 to 48 VDC
- Independent long or short ON-/OFF-time settings are possible
- Smart Dial/Selector-Locking Mechanism prevents the dials and selectors on the Timer's front panel from being operated without authorization. (The Lock can only be unlocked and locked with an optional pen-type Lock Key.)
- Repeat-cycle can be set for ON-start or OFF-start by terminal connection
- Time range from 0.1 second to 12 hours
- Finger-protection terminal block



Ordering Information

■ Timers

Description	Supply voltage	Part number	
		Screw terminal type	Cage clamp type
Independent ON-time/ Off-time operation	24 to 230 VAC (50/60 Hz)/24 to 48 VDC	H3DS-FL AC 24-230/DC 24-48	H3DS-FLC AC 24-230/DC 24-48

■ Model Number Legend

H3DS -F L □
1 2 3

1. F: Twin timer
2. L: Smart lock mechanism
3. None: Screw terminal type
C: Cage clamp type

■ Accessories (Order Separately)

Description	Part number
Lock key	Y92S-38
Mounting track	50 cm (l) x 7.3 mm (t)
	1 m (l) x 7.3 mm (t)
	1 m (l) x 16 mm (t)
End plate	PFP-M
Spacer	PFP-S

Specifications

■ General

Item	H3DS-F
Operating mode	Repeat-cycle with independent ON-time/OFF-time settings
Output type	Relay: SPDT
External connections	Screw terminal, cage clamp type
Terminal block	Screw terminal type: Clamps two 2.5-mm ² max. bar terminals without sleeves. Cage clamp type: Clamps two 1.5-mm ² max. bar terminals without sleeves.
Terminal screw tightening torque	0.98 N • m max.
Mounting method	DIN track mounting (see note)
Attachment	Nameplate label
Approved standards	UL508, CSA C22.2 No.14 Conforms to EN61812-1, IEC60664-1 (VDE0110) 4 kV/2, VDE0106/P 100 Output category according to IEC60947-5-1 (AC-13; 250 V 5A/AC-15; 250 V 1 A/DC-13; 30 V 0.1 A)

Note: Can be mounted to 35 mm DIN Track with a plate thickness of 1 to 2.5 mm.

■ Time Ranges

Time scale display	Time range
0.1s	0.1 to 1.2
1 s	1 to 12 s
0.1 m	0.1 to 1.2 min
1 m	1 to 12 min
0.1 h	0.1 to 1.2 h
1 h	1 to 12 h

Note: When the time setting dial is set to “0” for any time scale, the output will operate instantaneously.

■ Ratings

Rated supply voltage (See note.)	24 to 230 VAC (50/60 Hz)/24 to 48 VDC
Operating voltage range	85% to 110% of rated supply voltage
Power reset	Minimum power-off time: 0.1 s
Reset voltage	2.4 VAC/DC max.
Power consumption	AC: 33 VA max./2.2 W max. (typical: 31 VA/2.0 W) at 230 VAC; 11 VA max./1.9 W max. (typical: 9.7 VA/1.7 W) at 100 to 120 VAC DC: 0.7 W max. (typical: 0.6 W) at 24 VDC; 1.4 W max. (typical: 1.2 W) at 48 VDC
Voltage input	Max. permissible capacitance between inputs lines (terminals B1 and A2): 2,000 pF Load connectable in parallel with inputs (terminals B1 and A1). H-level: 20.4 to 253 VAC/20.4 to 52.8 VDC L-level: 0 to 2.4 VAC/DC
Control output	Contact output: 5 A at 250 VAC with resistive load (cos φ = 1); 5 A at 30 VDC with resistive load (cos φ = 1)
Ambient temperature	Operating: -10°C to 55°C (14°F to 131°F) with no icing Storage: -25°C to 65°C (-13°F to 145°F) with no icing
Ambient humidity	Operating: 35% to 85%

Note: DC ripple rate: 20% max.

■ Characteristics

Accuracy of operating time	±1% max. of FS (±1% ±10 ms max. at 1.2-s range)
Setting error	±10% ±50 ms max. of FS
Influence of voltage	±0.5% max. of FS (±0.5% ±10 ms max. at 1.2-s range)
Influence of temperature	±2% max. of FS (±2% ±10 ms max. at 1.2-s range)
Insulation resistance	100 MΩ min. at 500 VDC
Dielectric strength	Between current-carrying metal parts and exposed non-current-carrying metal parts: 2,000 VAC (50/60 Hz) for 1 min. Between control output terminals and operating circuit: 2,000 VAC (50/60 Hz) for 1 min. Between contacts not located next to each other: 1,000 VAC (50/60 Hz) for 1 min.
Impulse withstand voltage	3 kV (between power supply terminals) 4.5 kV (between current-carrying metal parts and exposed non-current-carrying metal parts)
Noise immunity	Square-wave noise generated by noise simulator (pulse width: 100 ns/1 μs, 1-ns rise) ±1.5 kV
Static immunity	Malfunction: 4 kV Destruction: 8 kV
Vibration resistance	Malfunction: 0.5-mm single amplitude at 10 to 55 Hz Destruction: 0.75-mm single amplitude at 10 to 55 Hz
Shock resistance	Malfunction: 200 m/s ² , 3 times each in 6 directions Destruction: 300 m/s ² , 3 times each in 6 directions
Life expectancy	Mechanical: 10 million operations min. (under no load at 1,800 operations/h) Electrical: 100,000 operations min. (5 A at 250 VAC, resistive load at 360 operations/h) (see note)
EMC	(EMI) Emission Enclosure: EN55011 Group 1 class B Emission AC Mains: EN55011 Group 1 class B (EMS) Immunity ESD: EN61000-4-2: 6 kV contact discharge (level 3) 8 kV air discharge (level 3) Immunity RF-interference from AM Radio Waves: EN61000-4-3: 10 V/m (80 MHz to 1 GHz) (level 3) Immunity Burst: EN61000-4-4: 2 kV power port and output port (level 3) 1 kV control port with capacitive clamp (level 3) Immunity Surge: EN61000-4-5: 2 kV common mode (level 3) 1 kV differential mode (level 3)
Case color	Light gray (5Y7/1)
Degree of protection	IP30 (IP20 for terminal block)
Weight	Approx. 70 g

Note: For reference:
 A maximum current of 0.15 A can be switched at 125 VDC ($\cos \phi = 1$).
 A maximum current of 0.1 A can be switched if L/R is 7 ms.
 In both cases, a life of 100,000 operations can be expected.
 The minimum applicable load is 10 mA at 5 VDC (failure level: P).

Nomenclature

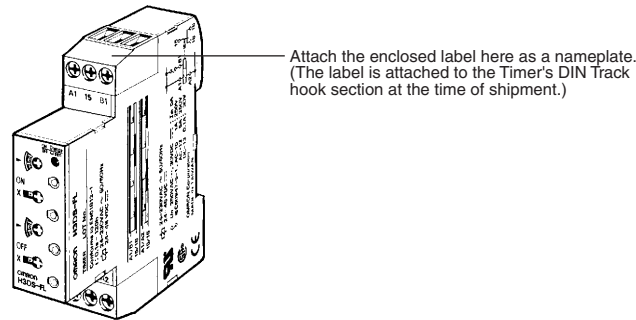
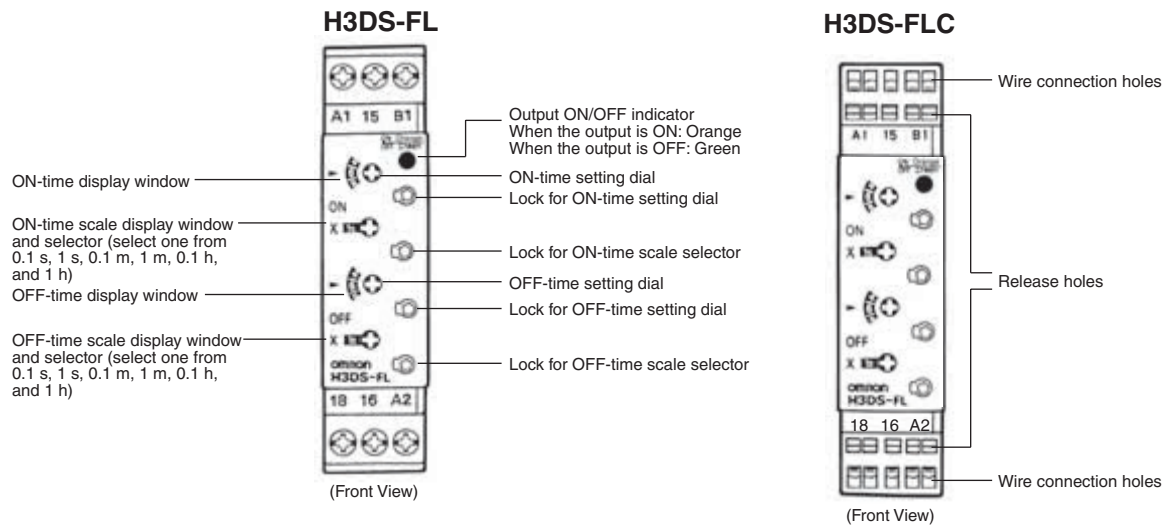

Operation

■ Block Diagram

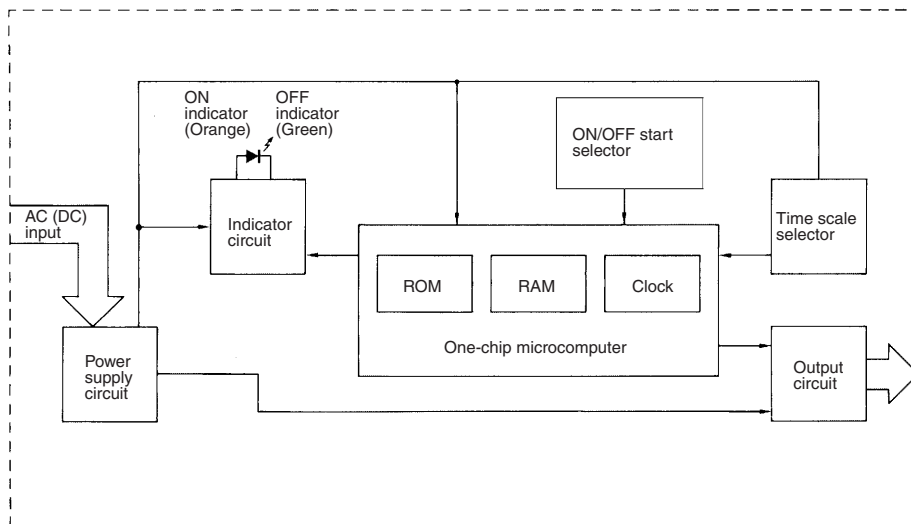

■ I/O Function

Inputs		ON-start operation begins when inputs are turned ON.
Outputs	Control output	Outputs are turned ON/OFF according to the time set by the ON-time and OFF-time setting dial.

■ Basic Operation

Selector Settings

The selectors can be turned clockwise and counterclockwise to select the desired time scale or operating mode.

Each selector has a snap mechanism that secures the selector at a given position. Set the selector at a position at which it is secured. Do not set it midway between two secure positions, or a malfunction could result from improper setting.

Settings for ON-Start/OFF-Start

If voltage is applied to terminal B1, or if terminals A1 and B1 are shorted, the operating mode is switched to ON-start mode. If these terminals are disconnected, the mode switches to OFF-start mode. The operating mode will not change if the state of the applied voltage changes during timer operation.

Selection of Time Scale

The time scale is selected by turning the ON-time scale selector and OFF-time scale selector. The time scales will appear in the following order in each time scale display window on the left of the selector:

0.1 s, 1 h, 0.1 h, 1 m, 1 s, 0.1 h, 0.1 m, 1 s.

Note: The time scales "1 s" and "0.1 h" appear twice. Both instances indicate exactly the same time scale.

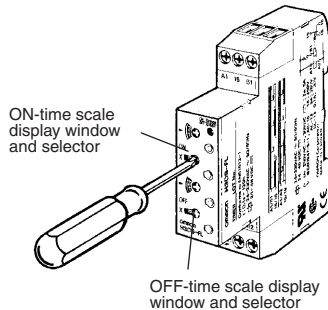

Time Setting

Use the ON-/OFF-time setting dials to set the ON-/OFF time.

Locking/Unlocking Selectors and the Time Setting Dial

The ON-/OFF-time setting dials and time scale selectors can be locked using the Y92S-38 Lock Key, a special pen type tool that is sold separately. To lock the dials or selectors, insert the Lock Key in the keyhole to the lower right of the dial or selector and turn it clockwise until the dial or selector is completely covered with the red cover. To unlock, turn the Lock Key in the opposite direction.

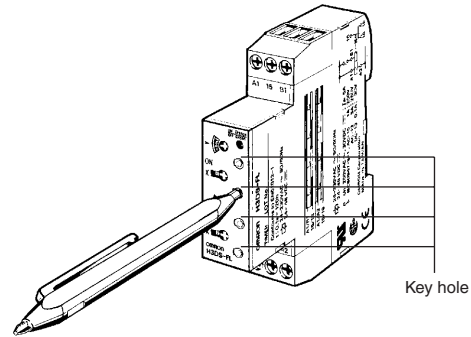

■ Timing Charts

Operating mode	Timing chart
<p>OFF-start (See note 1.)</p>	<p>Power (A₁ and A₂) ON OFF</p> <p>Output relay: NO 15 and 18 (ON indicator) ON OFF</p> <p>Output relay: NC 15 and 16 ON OFF</p> <p>OFF indicator ON OFF</p> <p>t_{ON}: ON set time t_{OFF}: OFF set time</p>
<p>ON-start (See notes 1 and 3.)</p>	<p>Power (A₁ and A₂) ON OFF</p> <p>Signal (B₁ and A₂) ON OFF</p> <p>Output relay: NO 15 and 18 (ON indicator) ON OFF</p> <p>Output relay: NC 15 and 16 ON OFF</p> <p>OFF indicator ON OFF</p> <p>t_{ON}: ON set time t_{OFF}: OFF set time</p>

- Note:**
1. If voltage is applied to terminal B1, or if terminals A1 and B1 are shorted, the operating mode is switched to ON-start mode. If these terminals are disconnected, the mode switches to OFF-start mode.
 2. The reset time requires a minimum of 0.1 s.
 3. When power is supplied in ON-start mode, the OFF indicator lights momentarily. This, however, has no effect on the performance of the Timer.

Dimensions

Unit: mm (inch)

■ H3DS-FL

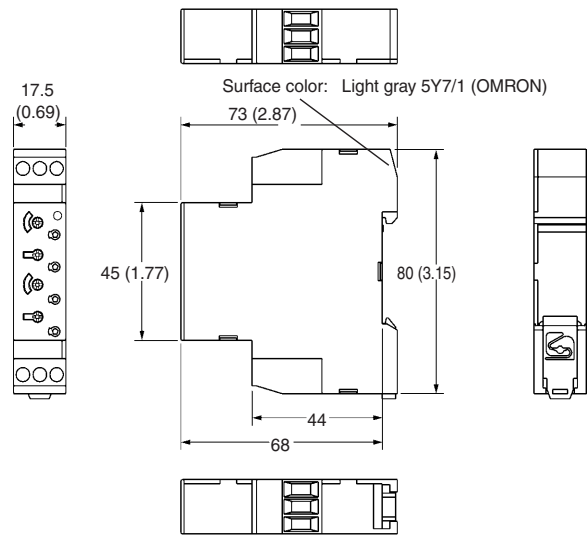
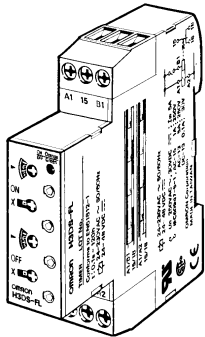

■ H3DS-FLC

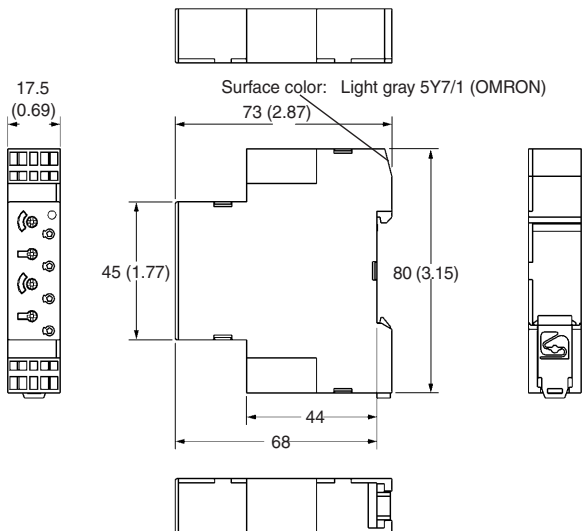
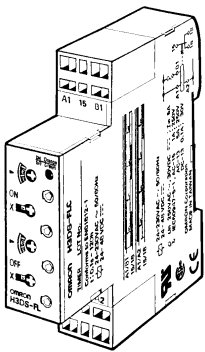

Accessories (Order Separately)

Unit: mm (inch)

■ Lock Key Y92S-38

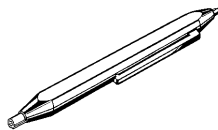

Unit: mm (inch)

■ Mounting Track

PFP-100N, PFP-50N

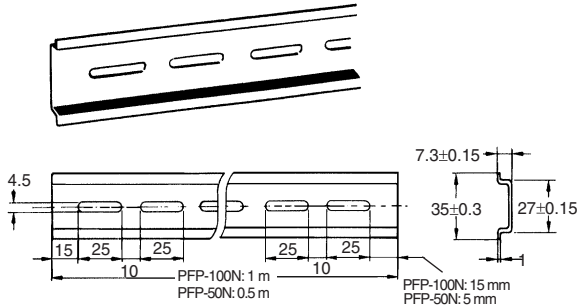

PFP-100N2

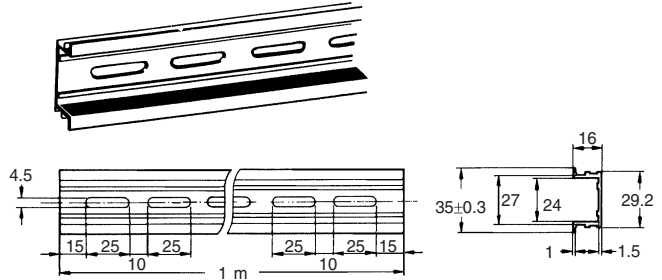

■ End Plate

PFP-M

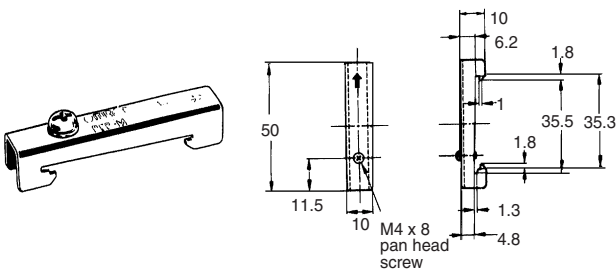

■ Spacer

PFP-S

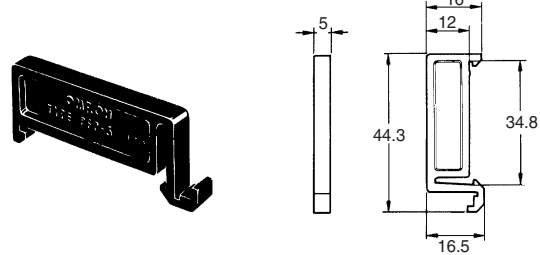

Installation

■ Terminal Arrangement

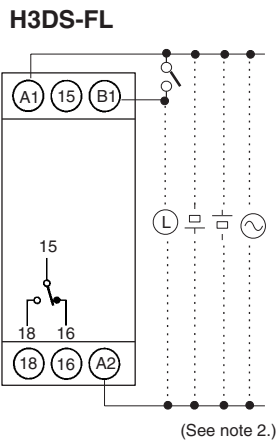
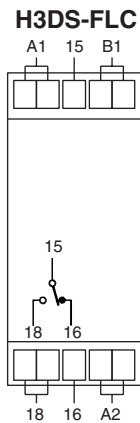

- Note:**
1. If voltage is applied to terminal B1, or if terminals A1 and B1 are shorted, the operating mode is switched to ON-start mode. If these terminals are disconnected, the mode switches to OFF-start mode.
 2. DC supply voltage does not require the designation of polarity.

Installation of Cage Clamp Terminal Models

■ Tools

A flat-blade screwdriver should be used to install the cables.

Applicable Screwdriver

- Flat-blade, Parallel-tip, 2.5 mm diameter

- Flat-blade, Parallel-tip



- Flat-blade, Flared-tip

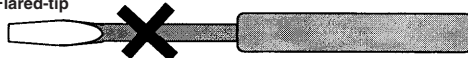

Cannot be used.

Examples: FACOM AEF.2.5 × 75E
VESSEL No. 9900-(-)2.5 × 75
WAGO 210-119
WIHA 260/2.5 × 40

■ Applicable Wires

Applicable Wire Sizes

0.2 to 1.5 mm², AWG24 to AWG16

Applicable Wire Type

Solid wires, stranded wires, flexible wires, or wires with ferrules can be used.

(See note 1) $1.8 \leq \text{Diameter } D \text{ (mm)} \leq 3.0$ (see note 2)

Conductor diameter d (mm) or length of sides a and b (mm) ≤ 1.6

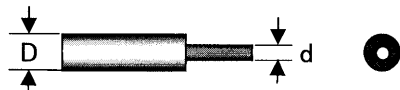

Wires with Ferrules



- Note:**
1. If the overall diameter of the wire is less than 1.8 mm, do not insert the wire past the conductor. Refer to the following diagrams.
 2. If the overall diameter of the wire is over 2.8 mm, it will be difficult to use double wiring.



■ Wiring

Use wires of the applicable sizes specified above. The length of the exposed conductor should be 6 to 7 mm.

Fig. 1 Exposed Conductor Length

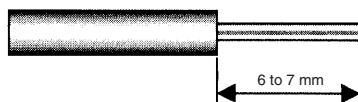

Use the following procedure

1. Insert the specified screwdriver into the release hole located beside the wire connection hole where the wire is to be inserted.

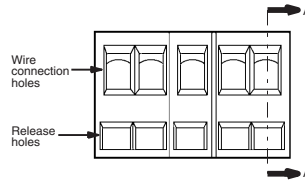

Fig. 2 Wire Connection Holes and Release Holes

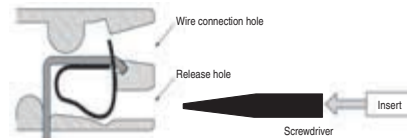
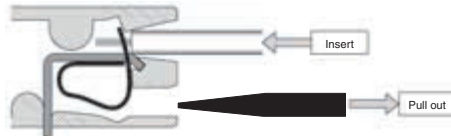

Fig. 3 Section A-A of Fig. 2

2. Insert the exposed conductor into the wire connection hole.



3. Pull out the screwdriver.



Wiring Precautions

Always insert the screwdriver straight into the hole, never at an angle. The clamp spring may bend if the screwdriver is not straight.

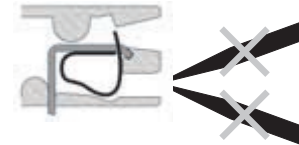

Do not move the screwdriver side to side in the clamp hole. The clamp spring may bend if the screwdriver is moved sideways.



Precautions

■ Setting Changes

⚠ WARNING

Do not change the time scale or operating mode while the Timer is in operation, or malfunction could result.

■ Power Supplies

The H3DS Series has a transformerless power supply system. Touching the input terminal while power is being supplied can cause you to get an electrical shock.

Use the bar terminal for wiring the H3DS. Using a stranded-wire terminal may cause a short-circuit due to a stray wire entering into the Timer.

Both AC and DC power supplies can be connected to the power input terminals without regarding polarity.

A DC power supply can be connected if its ripple factor is 20% or less and the mean voltage is within the rated operating voltage range of the Timer.

Make sure that the voltage is applied within the specified range, or the internal elements of the Timer may be damaged.

Connect the power supply voltage through a relay or switch in such a way that the voltage reaches a fixed value at once or the Timer may not be reset or a timer error could result.

■ Installation

If the load current is continuously being supplied to the Timer for a long period of time, be sure to provide the mounting clearance as shown in the figure below. If used under conditions other than those specified below, the life of internal components may be shortened due to an excessive rise in the internal temperature.

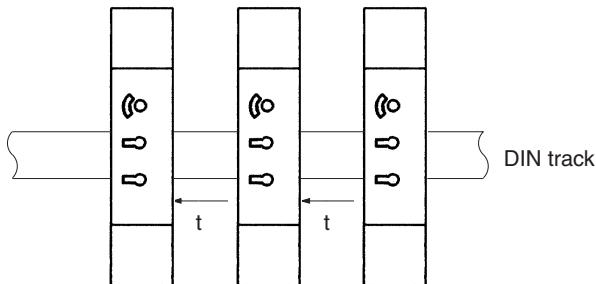

t: Mounting clearance (mm)

Switching Current vs. Ambient Temperature (When Mounting Two or More H3DS Units Side-by-Side)

H3DS-FL□

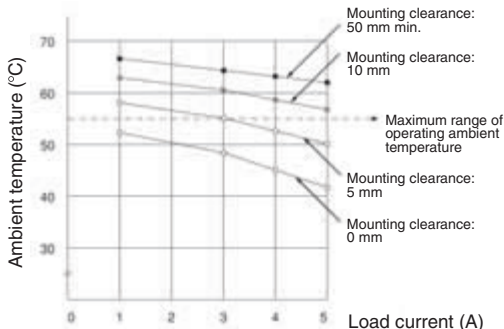

(Measurement Condition: Input voltage of 230 VAC)

■ Precautions for EN61812-1 Conformance

The H3DS as a built-in timer conforms to EN61812-1 provided that the following conditions are satisfied:

The output section of the H3DS is provided only with basic isolation. To ensure reinforced isolation required by the EN61812-1, provide supplementary basic isolation on the load side connected to the output.

The H3DS itself is designed according to the following:

- Overvoltage category III
- Pollution degree 2

On the above basis:

Operation parts on the front and bottom: Reinforced isolation

–With clearance of 5.5 mm and creepage distance of 5.5 mm at 230 VAC

Output: Basic isolation

–With clearance of 3 mm and creepage distance of 3 mm at 230 VAC

■ Environment

When using the Timer in an area with excess electrical noise, separate the Timer, wiring, and the equipment which generates the input signals as far as possible from the noise sources. Shield the input signal wiring to prevent electrical interference.

Organic solvents (such as paint thinner), as well as very acidic or basic solutions, can damage the outer casing of the Timer.

Do not use the Timer in places where it is exposed to dust, corrosive gas, or direct sunlight.

When storing the Timer, make sure that the ambient temperature and humidity are within the rated values. Leave the Timer at room temperature for at least three hours before using the Timer if it has been stored at an ambient temperature of -10°C or below.

■ Voltage Withstand Test

If the Timer is mounted on a control board, remove the Timer from the control board or short-circuit the circuitry of the power board before carrying out a voltage withstand test between the electrical circuitry and non-current-carrying metal part of the Timer, in order to prevent the internal circuitry of the Timer from damage.

ALL DIMENSIONS SHOWN ARE IN MILLIMETERS.

To convert millimeters into inches, multiply by 0.03937. To convert grams into ounces, multiply by 0.03527.

OMRON**OMRON ELECTRONICS LLC**

One East Commerce Drive
Schaumburg, IL 60173

1-800-55-OMRON**OMRON ON-LINE**

Global - <http://www.omron.com>
USA - <http://www.omron.com/oei>
Canada - <http://www.omron.com/oci>

OMRON CANADA, INC.

885 Milner Avenue
Scarborough, Ontario M1B 5V8

416-286-6465

Star-Delta Timer

H3DS-G

17.5 mm Star-Delta Timer Designed for Track Mounting

- A wide AC/DC power supply range, 24 to 230 VAC/24 to 48 VDC
- A wide star-time range up to 120 seconds, and delta-transfer time range up to 1 second
- Smart Dial/Selector-Locking Mechanism prevents the dials and selectors on the Timer's front panel from being operated without authorization. (The lock can only be unlocked and locked with an optional pen-type Lock key.)
- Finger-protection terminal block

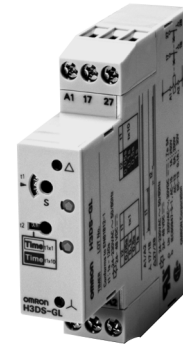

Ordering Information

Description	Supply voltage	Part number	
		Screw terminal type	Cage clamp type
Star-delta timer	24 to 230 VAC (50/60 Hz)/24 to 48 VDC	H3DS-GL AC 24-230/DC 24-48	H3DS-GLC AC 24-230/DC 24-48

Model Number Legend

H3DS -G L □
1 2 3

1. G: Star-delta timer
2. L: Smart lock mechanism
3. None: Screw terminal type
C: Cage clamp type

Accessories (Order Separately)

Description		Part number
Lock key		Y92S-38
Mounting track	50 cm (l) x 7.3 mm (t)	PFP-50N
	1 m (l) x 7.3 mm (t)	PFP-100N
	1 m (l) x 16 mm (t)	PFP-100N2
End plate		PFP-M
Spacer		PFP-S

Specifications

■ General

Item	H3DS-G
Operating mode	Star-delta operation
Operating/Reset method	Time-limit operation/Self-reset
External connections	Screw terminal, cage clamp
Terminal block	Screw terminal type: Clamps two 2.5-mm ² max. bar terminals without sleeves. Cage clamp type: Clamps two 1.5-mm ² max. bar terminals without sleeves.
Terminal screw tightening torque	0.98 N • m max.
Output type	(Star operation circuit) Relay: SPST-NO (Delta operation circuit) Relay: SPST-NO
Mounting method	DIN track mounting (see note)
Attachment	Nameplate label
Approved standards	UL508, CSA C22.2 No.14 Conforms to EN61812-1, IEC60664-1 (VDE0110) 4 kV/2, VDE0106/P100 Output category according to IEC60947-5-1 (AC-13; 250 V 5A/AC-15; 250 V 1 A/DC-13; 30 V 0.1 A)

Note: Can be mounted to 35-mm DIN Track with a plate thickness of 1 to 2.5 mm.

■ Time Ranges

Time scale	Star operation time ranges
x 1	1 to 12 s
x 10	10 to 120 s

■ Transfer Time

Star-delta transfer time	Programmable at 0.05 s, 0.1 s, 0.5 s, or 1 s
--------------------------	--

■ Ratings

Rated supply voltage (see note)	24 to 230 VAC (50/60 Hz)/24 to 48 VDC
Operating voltage range	85% to 110% of rated supply voltage
Power reset	Minimum power-off time: 0.5 s
Reset voltage	2.4 VAC/DC max.
Power consumption	AC: 21 VA max./1.7 W max. (typical: 20 VA/1.6 W) at 230 VAC; 11 VA max./2.0 W max. (typical: 8.6 VA/1.5 W) at 100 to 120 VAC DC: 1.3 W max. (typical: 1.2 W) at 24 VDC; 0.7 W max. (typical: 0.6 W) at 48 VDC
Control output	Contact output: 5 A at 250 VAC with resistive load ($\cos \phi = 1$) 5 A at 30 VDC with resistive load ($\cos \phi = 1$)
Ambient temperature	Operating: -10°C to 55°C (14°F to 131°F) with no icing Storage: -25°C to 65°C (-13°F to 145°F) with no icing
Ambient humidity	Operating: 35% to 85%

Note: DC ripple rate: 20% max.

■ Characteristics

Accuracy of operating time	±1% max. of FS
Setting error	±10% ± 50 ms max. of FS
Total tolerance of transfer time	± (25% FS + 5 ms) max.
Influence of voltage	±0.5% max. of FS
Influence of temperature	±2% max. of FS
Insulation resistance	100 MΩ min. at 500 VDC
Dielectric strength	Between current-carrying metal parts and exposed non-current-carrying metal parts: 2,000 VAC (50/60 Hz) for 1 min. Between control output terminals and operating circuit: 2,000 VAC (50/60 Hz) for 1 min. Between contacts not located next to each other: 1,000 VAC (50/60 Hz) for 1 min.
Impulse withstand voltage	3 kV (between power supply terminals) 4.5 kV (between current-carrying metal parts and exposed non-current-carrying metal parts)
Noise immunity	Square-wave noise generated by noise simulator (pulse width: 100 ns/1 μs, 1-ns rise) ±1.5 kV
Static immunity	Malfunction: 4 kV Destruction: 8 kV
Vibration resistance	Malfunction: 0.5-mm single amplitude at 10 to 55 Hz Destruction: 0.75-mm single amplitude at 10 to 55 Hz
Shock resistance	Malfunction: 200 m/s ² , 3 times each in 6 directions Destruction: 300 m/s ² , 3 times each in 6 directions
Life expectancy	Mechanical: 10 million operations min. (under no load at 1,800 operations/h) Electrical: 100,000 operations min. (5 A at 250 VAC, resistive load at 360 operations/h) (see note)
EMC	(EMI) Emission Enclosure: EN55011 Group 1 class B Emission AC Mains: EN55011 Group 1 class B (EMS) Immunity ESD: EN61000-4-2: 6 kV contact discharge (level 3) 8 kV air discharge (level 3) Immunity RF-interference from AM Radio Waves: EN61000-4-3: 10 V/m (80 MHz to 1 GHz) (level 3) Immunity Burst: EN61000-4-4: 2 kV power port and output port (level 3) 1 kV control port with capacitive clamp (level 3) Immunity Surge: EN61000-4-5: 2 kV common mode (level 3) 1 kV differential mode (level 3)
Case color	Light gray (5Y7/1)
Degree of protection	IP30 (IP20 for terminal block)
Weight	Approx. 70 g

Note: For reference:
 A maximum current of 0.15 A can be switched at 125 VDC (cos φ = 1).
 A maximum current of 0.1 A can be switched if L/R is 7 ms.
 In both cases, a life of 100,000 operations can be expected.
 The minimum applicable load is 10 mA at 5 VDC (failure level: P).

Nomenclature

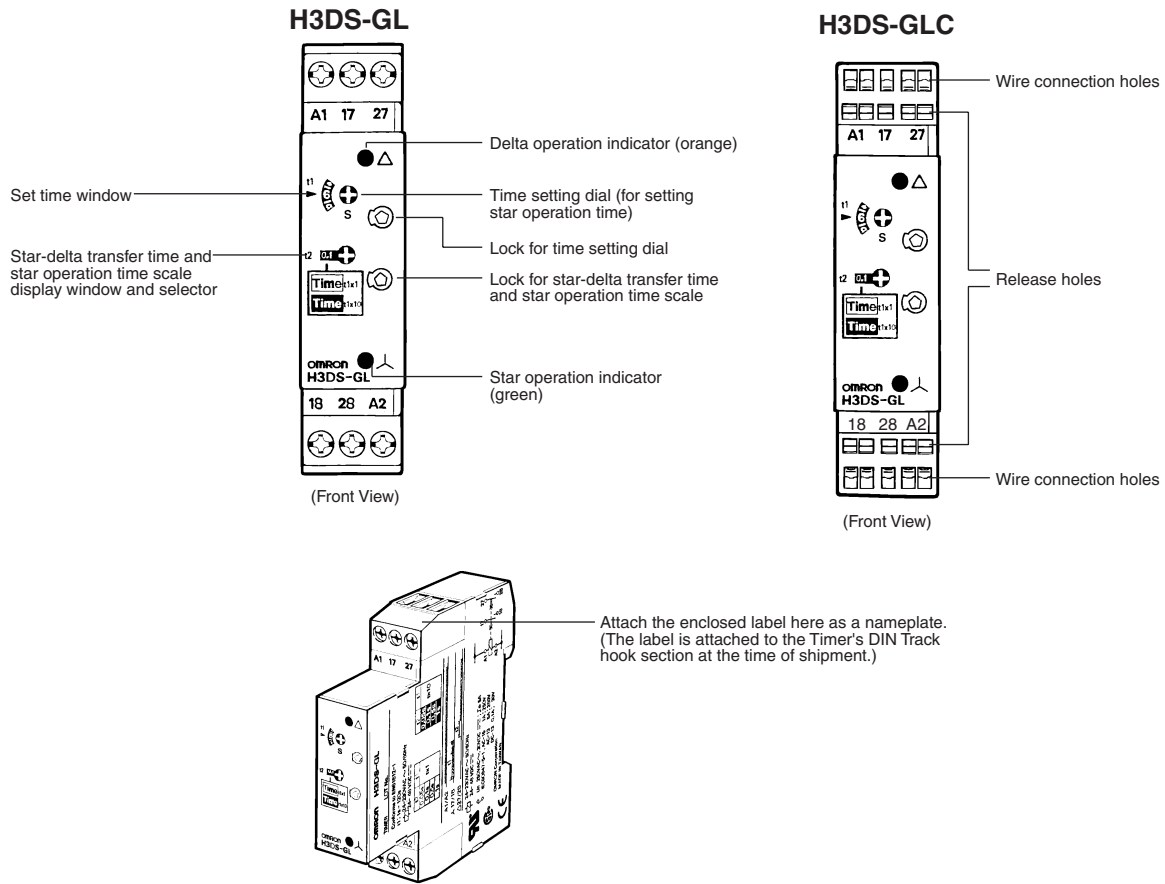

Operation

■ Block Diagram

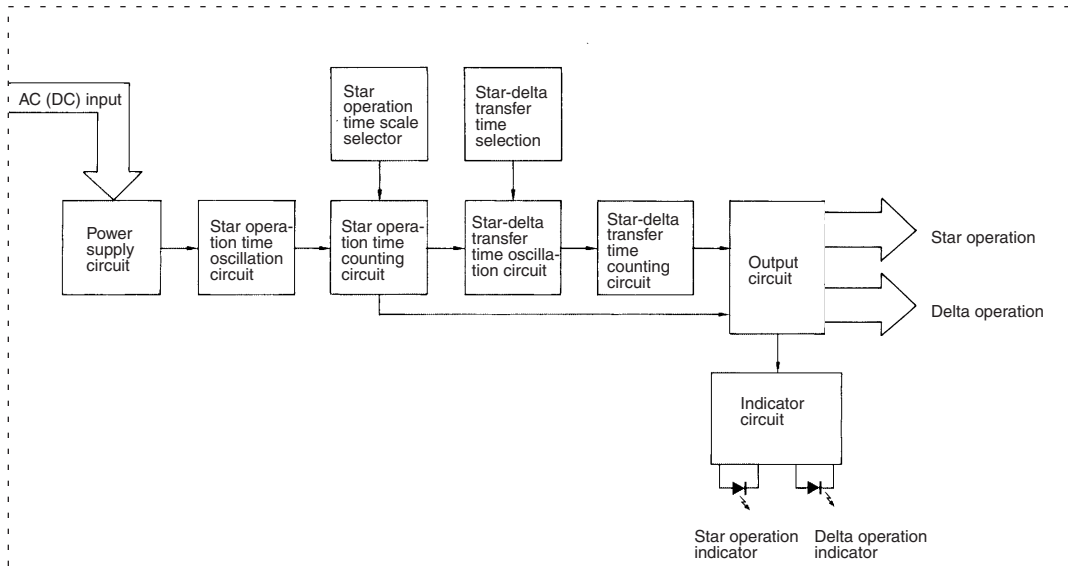

■ I/O Functions

Inputs		---
Outputs	Control output	Star output is turned OFF when the dial set value is reached and delta output is ON after the preset transfer time elapses

■ Basic Operation

Setting of Selector

The selectors can be turned clockwise and counterclockwise to select the desired time scale, or operating mode.

Each selector has a snap mechanism that secures the selector at a given position. Set the selector at a position at which it is secured. Do not set it midway between two securing positions or a malfunction could result from improper setting.

Selection of Time Unit and Time Scale

The star-delta transfer time and star operation time scale are set with the same selector. The star-delta transfer time can be set to 0.05, 0.1, 0.5, or 1. The star operation time scale can be set to a multiplication factor of 1 or 10. If the star-delta transfer time is displayed in the display window in white letters, this means that the star operation time scale is "x10". Refer to the example below.

Star-delta transfer time	Star operation time scale
0.05 s	x1
0.1 s	
0.5 s	
1 s	
0.05 s	x10
0.1 s	
0.5 s	
1 s	

Time Setting

The star operation time of the Timer is set with the time setting dial.

Locking/Unlocking of Selectors and Time Setting Dial

The time setting dial and time scale selector can be locked using the Y92S-38 Lock Key, a special pen type tool that is sold separately. To lock the dial or selectors, insert the Lock Key in the key-hole to the lower right of the dial or selector and turn it clockwise until the dial or selector is completely covered with the red cover. To unlock, turn the Lock Key in the opposite direction.

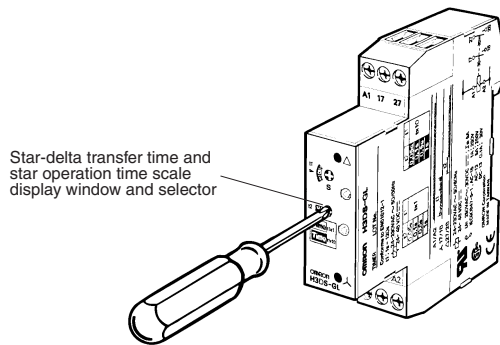
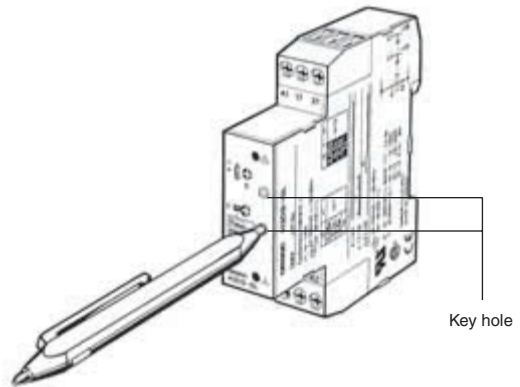

■ Timing Charts

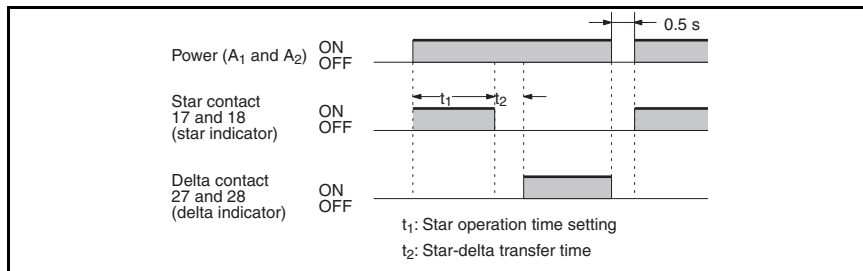

Note: The reset time requires a maximum of 0.5 s.

Dimensions

Unit: mm (inch)

■ H3DS-GL

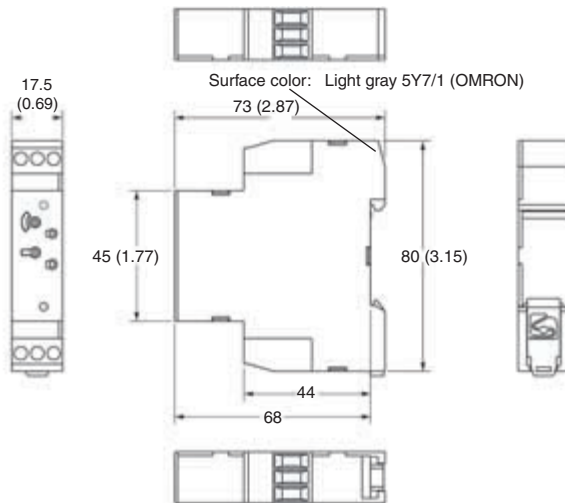
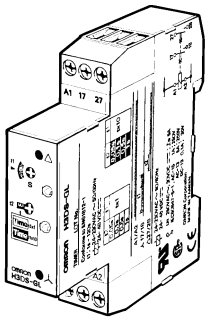

■ H3DS-GLC

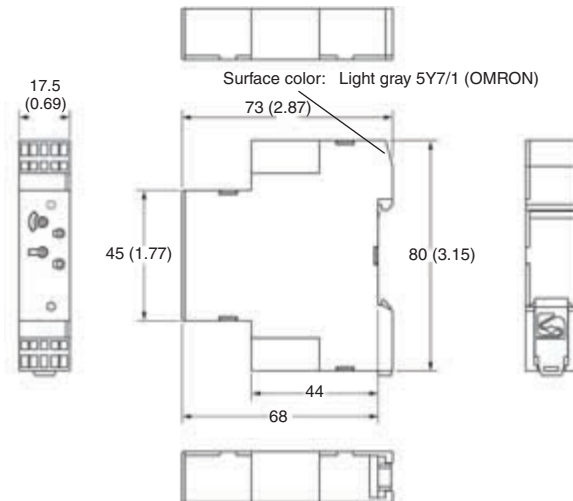
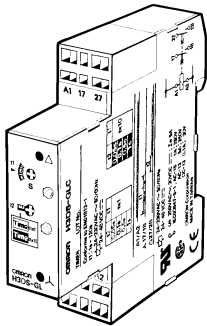

Accessories (Order Separately)

■ Lock Key Y92S-38

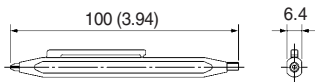
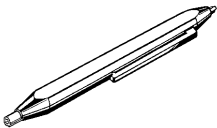

Unit: mm (inch)

■ Mounting Track

PFP-100N, PFP-50N

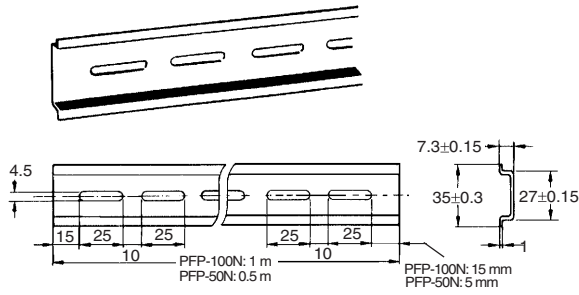

PFP-100N2

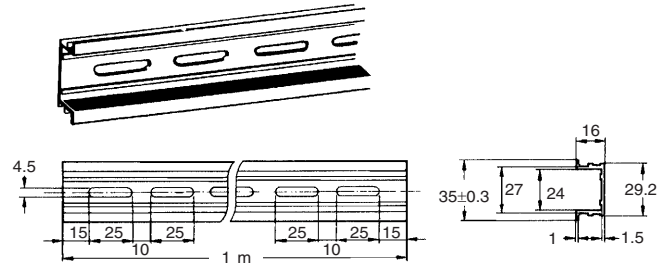

■ End Plate

PFP-M

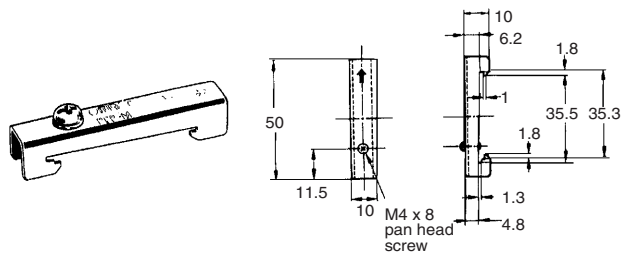

■ Spacer

PFP-S

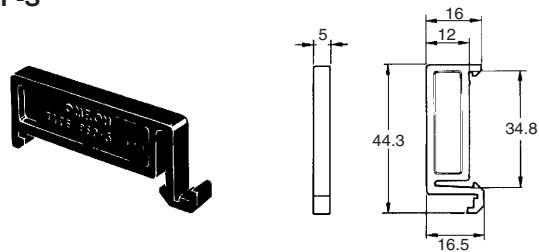

Installation

■ Terminal Arrangement

H3DS-GLC

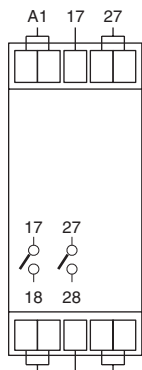

H3DS-GL

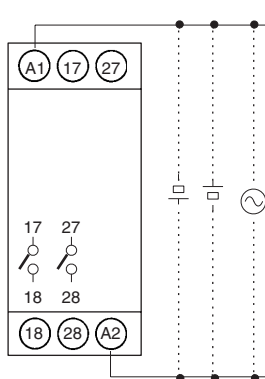

Note: DC supply voltage does not require the designation of polarity.

Installation of Cage Clamp Terminal Models

Tools

A flat-blade screwdriver should be used to install the cables.

Applicable Screwdriver

- Flat-blade, Parallel-tip, 2.5 mm diameter

- Flat-blade, Parallel-tip



- Flat-blade, Flared-tip

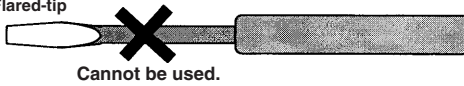

Examples: FACOM AEF.2.5 × 75E
VESSEL No. 9900(-)2.5 × 75
WAGO 210-119
WIHA 260/2.5 × 40

Applicable Wires

Applicable Wire Sizes

0.2 to 1.5 mm², AWG24 to AWG16

Applicable Wire Type

Solid wires, stranded wires, flexible wires, or wires with ferrules can be used.

(See note 1) $1.8 \leq \text{Diameter } D \text{ (mm)} \leq 3.0$ (see note 2)

Conductor diameter d (mm) or length of sides a and b (mm) ≤ 1.6

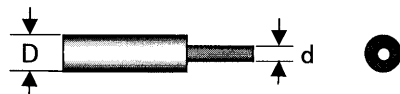

Wires with Ferrules



- Note:**
1. If the overall diameter of the wire is less than 1.8 mm, do not insert the wire past the conductor. Refer to the following diagrams.
 2. If the overall diameter of the wire is over 2.8 mm, it will be difficult to use double wiring.



Wiring

Use wires of the applicable sizes specified above. The length of the exposed conductor should be 6 to 7 mm.

Fig. 1 Exposed Conductor Length

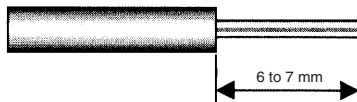

Use the following procedure

1. Insert the specified screwdriver into the release hole locate beside the wire connection hole where the wire is to be inserted.

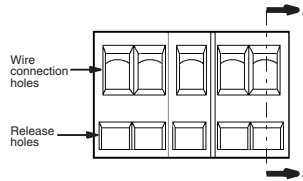

Fig. 2 Wire Connection Holes and Release Holes

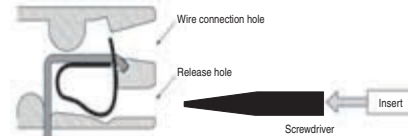

Fig. 3 Section A-A of Fig. 2



2. Insert the exposed conductor into the wire connection hole.



3. Pull out the screwdriver.

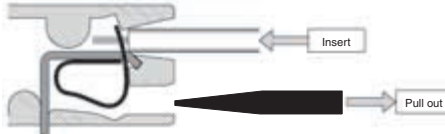

Wiring Precautions

Always insert the screwdriver straight into the hole, never at an angle. The clamp spring may bend if the screwdriver is not straight.

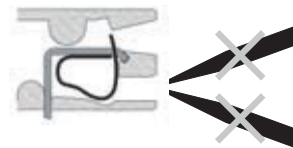

Do not move the screwdriver side to side in the clamp hole. The clamp spring may bend if the screwdriver is moved sideways.



Precautions

■ Setting Changes

— ⚠ WARNING —

Do not change the time scale or operating mode while the Timer is in operation, or malfunction could result.

■ Power Supplies

The H3DS Series has a transformerless power supply system. Touching the input terminal while power is being supplied can cause you to get an electrical shock.

Use the bar terminal for wiring the H3DS. Using a stranded-wire terminal may cause a short-circuit due to a stray wire entering into the Timer.

Both AC and DC power supplies can be connected to the power input terminals without regarding polarity.

With the H3DS only, a DC power supply must be connected to the power input terminals as designated according to the polarity of the terminals.

A DC power supply can be connected if its ripple factor is 20% or less and the mean voltage is within the rated operating voltage range of the Timer.

Make sure that the voltage is applied within the specified range, or the internal elements of the Timer may be damaged.

Connect the power supply voltage through a relay or switch in such a way that the voltage reaches a fixed value at once or the Timer may not be reset or a timer error could result.

■ Installation

If the load current is continuously being supplied to the Timer for a long period of time, be sure to provide the mounting clearance as shown in the figure below. If used under conditions other than those specified below, the life of internal components may be shortened due to an excessive rise in the internal temperature.

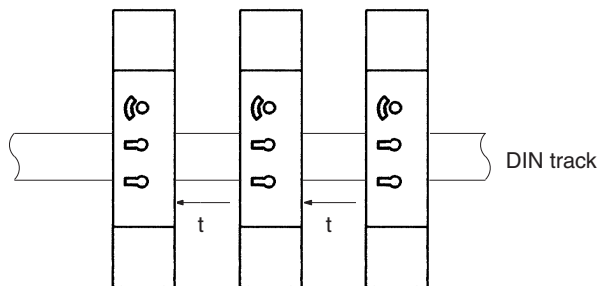

t: Mounting clearance (mm)

Switching Current vs. Ambient Temperature (When Mounting Two or More H3DS Units Side-by-Side)

H3DS-GL□

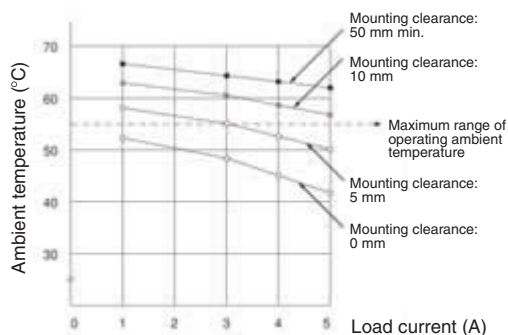

(Measurement Condition: Input voltage of 230 VAC)

■ Precautions for EN61812-1 Conformance

The H3DS as a built-in timer conforms to EN61812-1 provided that the following conditions are satisfied:

The output section of the H3DS is provided only with basic isolation. To ensure reinforced isolation required by the EN61812-1, provide supplementary basic isolation on the load side connected to the output.

The H3DS itself is designed according to the following:

- Overvoltage category III
- Pollution degree 2

On the above basis:

Operation parts on the front and bottom: Reinforced isolation

–With clearance of 5.5 mm and creepage distance of 5.5 mm at 230 VAC

Output: Basic isolation

–With clearance of 3 mm and creepage distance of 3 mm at 230 VAC

■ Environment

When using the Timer in an area with excess electrical noise, separate the Timer, wiring, and the equipment which generates the input signals as far as possible from the noise sources. Shield the input signal wiring to prevent electrical interference.

Organic solvents (such as paint thinner), as well as very acidic or basic solutions, can damage the outer casing of the Timer.

Do not use the Timer in places where it is exposed to dust, corrosive gas, or direct sunlight.

When storing the Timer, make sure that the ambient temperature and humidity are within the rated values. Leave the Timer at room temperature for at least three hours before using the Timer if it has been stored at an ambient temperature of -10°C or below.

■ Voltage Withstand Test

If the Timer is mounted on a control board, remove the Timer from the control board or short-circuit the circuitry of the power board before carrying out a voltage withstand test between the electrical circuitry and non-current-carrying metal part of the Timer, in order to prevent the internal circuitry of the Timer from damage.

ALL DIMENSIONS SHOWN ARE IN MILLIMETERS.

To convert millimeters into inches, multiply by 0.03937. To convert grams into ounces, multiply by 0.03527.

OMRON**OMRON ELECTRONICS LLC**

One East Commerce Drive
Schaumburg, IL 60173

1-800-55-OMRON**OMRON ON-LINE**

Global - <http://www.omron.com>
USA - <http://www.omron.com/oei>
Canada - <http://www.omron.com/oci>

OMRON CANADA, INC.

885 Milner Avenue
Scarborough, Ontario M1B 5V8

416-286-6465

Solid-State Two-Wired Timer

H3DS-X

17.5 mm Two-Wired Timer Designed for Track Mounting

- Wide AC/DC power supply range (24-230 VAC/VDC)
- Smart Dial/Selector-Locking Mechanism prevents the dials and selectors on the Timer's front panel from being operated without authorization. (The lock can only be unlocked and locked with an optional pen-type Lock key.)
- Time range of 0.1 second to 120 hours
- Finger-protection terminal block

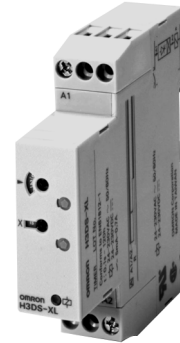

Ordering Information

Description	Supply voltage	Part number	
		Screw terminal type	Cage clamp type
ON-delay	24 to 230 VAC/VDC (50/60 Hz)	H3DS-XL AC/DC 24-230	H3DS-XLC AC/DC 24-230

Model Number Legend

H3DS -X L □
1 2 3

1. X: Two-wired timer
2. L: Smart lock mechanism
3. None: Screw terminal type
C: Cage clamp type

Accessories (Order Separately)

Description	Part number
Lock key	Y92S-38
Mounting track	50 cm (l) x 7.3 mm (t)
	1 m (l) x 7.3 mm (t)
	1 m (l) x 16 mm (t)
End plate	PFP-M
Spacer	PFP-S

Specifications

■ General

Item	H3DS-X
Operating mode	ON-delay
Operating/Reset method	Time-limit operation/self-resetting
Output type	SCR output
External connections	Screw terminal, cage clamp
Terminal block	Screw terminal type: Clamps two 2.5-mm ² max. bar terminals without sleeves. Cage clamp type: Clamps two 1.5-mm ² max. bar terminals without sleeves.
Terminal screw tightening torque	0.98 N • m max.
Output type	(Star operation circuit) Relay: SPST-NO (Delta operation circuit) Relay: SPST-NO
Mounting method	DIN track mounting (see note)
Attachment	Nameplate label
Approved standards	UL508, CSA C22.2 No.14 Conforms to EN61812-1, IEC60664-1 (VDE0110) 4 kV/2, VDE0106/P100

Note: Can be mounted to 35-mm DIN Track with a plate thickness of 1 to 2.5 mm.

■ Time Ranges

Time scale	Star operation time ranges
0.1 s	0.1 to 1.2 s
1 s	1 to 12 s
0.1 m	0.1 to 1.2 min
1 m	1 to 12 min
0.1 h	0.1 to 1.2 h
1 h	1 to 12 h
10 h	10 to 120 h

Note: When the time setting dial is set to "0" for any time scale, the output will operate instantaneously.

■ Ratings

Rated supply voltage (see note)	24 to 230 VAC/VDC (50/60 Hz)
Operating voltage range	85% to 110% of rated supply voltage
Power reset	Minimum power-off time: 0.1 s
Reset voltage	1.0 VAC/VDC max.
Reset current	5 mA max.
Power consumption	5 mA max.
Control output	SCR output: 5 mA to 0.7A
Ambient temperature	Operating: -10°C to 55°C (14°F to 131°F) with no icing Storage: -25°C to 65°C (-13°F to 145°F) with no icing
Ambient humidity	Operating: 35% to 85%

Note: DC ripple rate: 20% max.

■ Characteristics

Accuracy of operating time	±1% max. of FS (±1% ±10 ms max. at 1.2 s range)
Setting error	±10% ±50 ms max. of FS
Reset time	0.1 s max.
Influence of voltage	±0.5% max. of FS (±0.5% ±10 ms max. at 1.2 s range)
Influence of temperature	±2% max. of FS (±2% ±10 ms max. at 1.2 s range)
Insulation resistance	100 MΩ min. at 500 VDC
Dielectric strength	Between current-carrying metal parts and exposed non-current-carrying metal parts: 2,000 VAC for 1 min.
Impulse withstand voltage	3 kV (between power supply terminals) 4.5 kV (between current-carrying metal parts and exposed non-current-carrying metal parts)
Noise immunity	Square-wave noise generated by noise simulator (pulse width: 100 ns/1 μs, 1-ns rise) ±1.5 kV (between power supply terminals)
Static immunity	Malfunction: 4 kV Destruction: 8 kV
Vibration resistance	Malfunction: 0.5 mm single amplitude at 10 to 55 Hz Destruction: 0.75 mm single amplitude at 10 to 55 Hz
Shock resistance	Malfunction: 200 m/s ² , 3 times each in 6 directions Destruction: 300 m/s ² , 3 times each in 6 directions
EMC	(EMI) Emission Enclosure: EN55011 Group 1 class B Emission AC Mains: EN55011 Group 1 class B (EMS) Immunity ESD: EN61000-4-2: 6 kV contact discharge (level 3) 8 kV air discharge (level 3) Immunity RF-interference from AM Radio Waves: EN61000-4-3: 10 V/m (80 MHz to 1 GHz) (level 3) Immunity Burst: EN61000-4-4: 2 kV power port and output port (level 3) 1 kV control port with capacitive clamp (level 3) Immunity Surge: EN61000-4-5: 2 kV common mode (level 3) 1 kV differential mode (level 3)
Case color	Light gray (5Y7/1)
Degree of protection	IP30 (IP20 for terminal block)
Weight	Approx. 70 g

Nomenclature

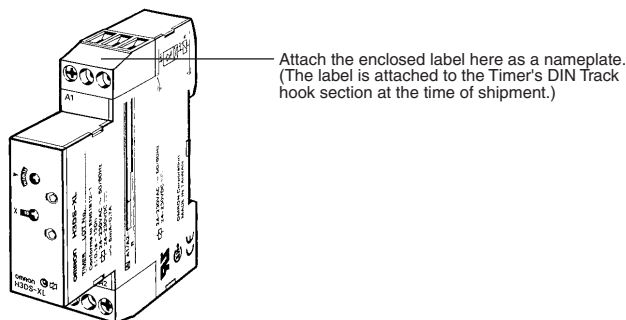
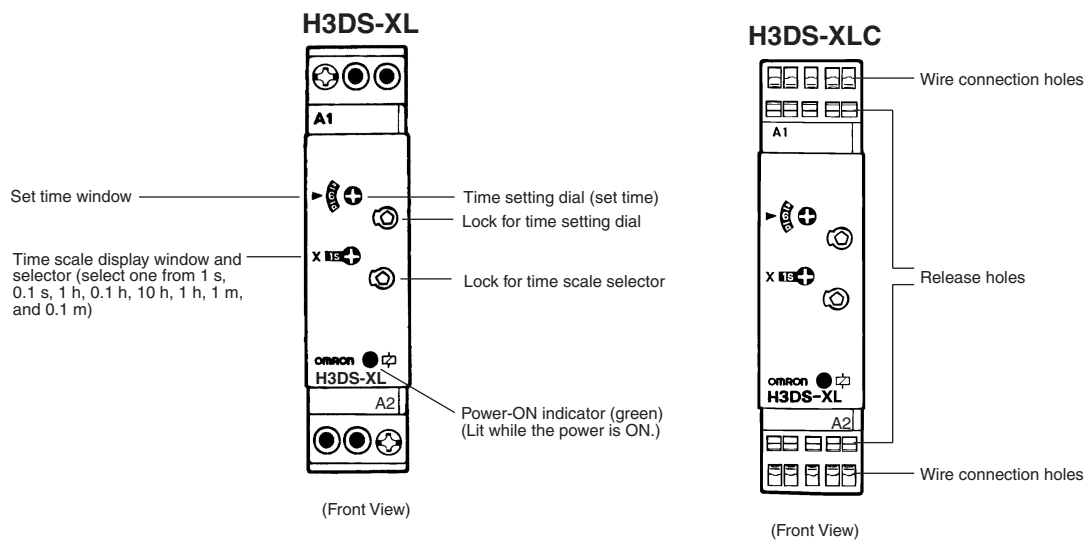

Operation

■ Block Diagram

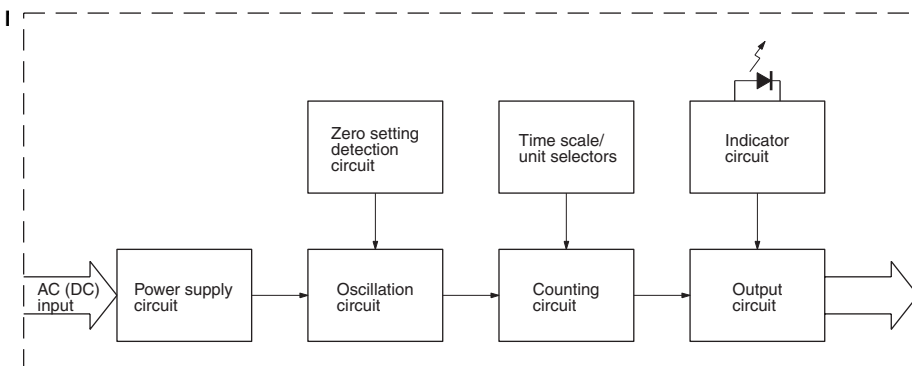

■ I/O Functions

Inputs		---
Outputs	Control output	Outputs are turned On when the preset value is reached.

■ Basic Operation
Selector Settings

The selectors can be turned clockwise and counterclockwise to select the desired time scale or operating mode.

Each selector has a snap mechanism that secures the selector at a given position. Set the selector at a position where it is secured. Do not set it midway between two secure positions, or a malfunction could result from improper setting.

Selection of Time Scale

To select the time scale, turn the time scale selector, and the time scales will appear (in the time scale display window on the left of the selector) in the order shown here:

1 s, 0.1 s, 1 h, 0.1 h, 10 h, 1 h, 1 m, 0.1 m.

Note: The time scale “1h” appears twice. Both instances indicate exactly the same time

Locking/Unlocking Selectors and the Time Setting Dial

The time setting dial and time scale selector can be locked using the Y92S-38 Lock Key, a special pen type tool that is sold separately. To lock the dial or selectors, insert the Lock Key in the keyhole to the lower right of the dial or selector and turn it clockwise until the dial or selector is completely covered with the red cover. To unlock, turn the Lock Key in the opposite direction.

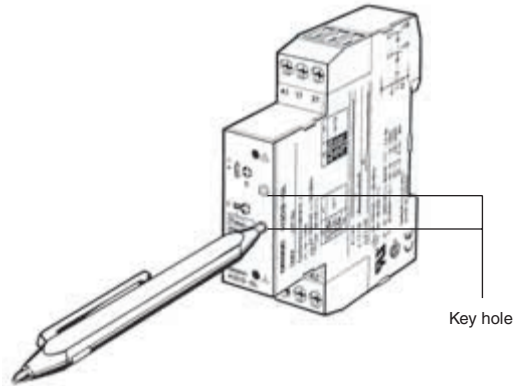
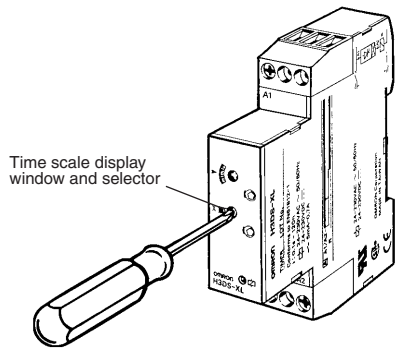

■ Timing Charts

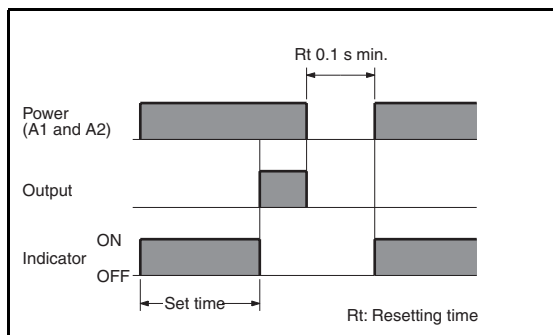

Dimensions

Unit: mm (inch)

■ H3DS-XL

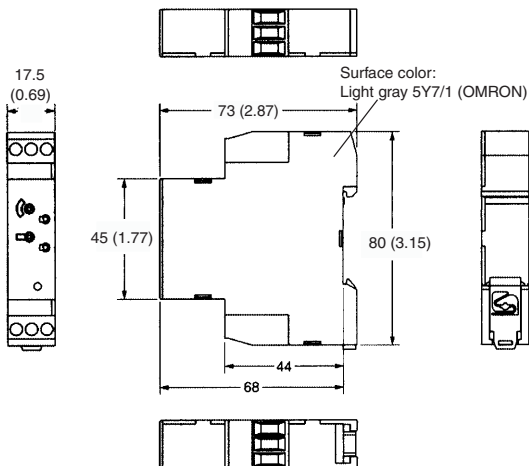
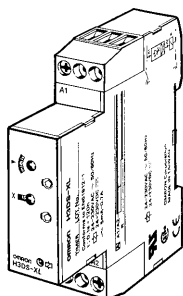

■ H3DS-XLC

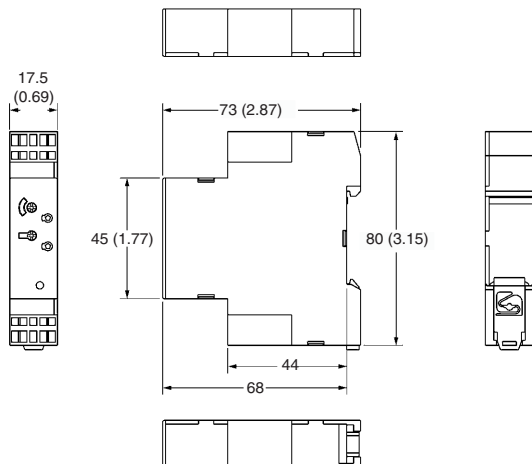
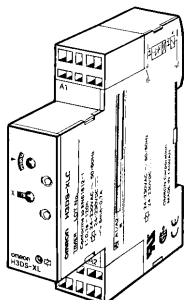

Accessories (Order Separately)

■ Lock Key Y92S-38

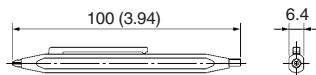
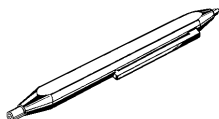

Unit: mm (inch)

■ Mounting Track

PFP-100N, PFP-50N

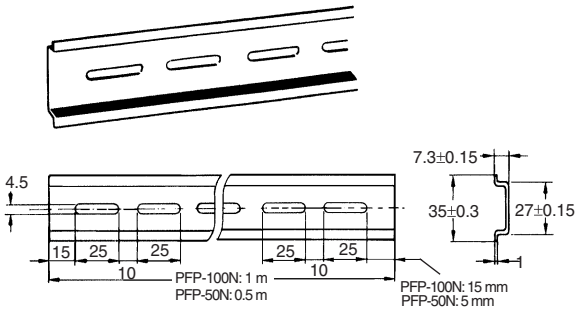

PFP-100N2

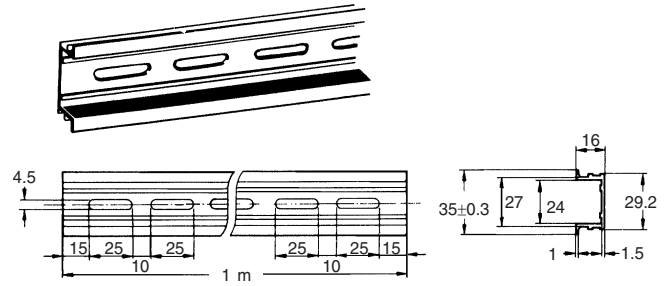

■ End Plate

PFP-M

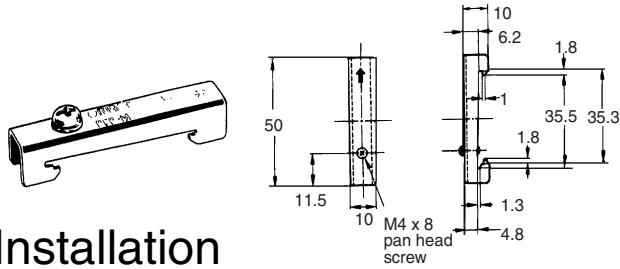

■ Spacer

PFP-S

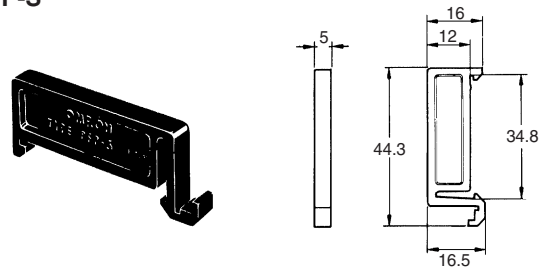

Installation

■ Terminal Arrangement

H3DS-XLC

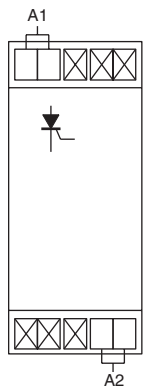

H3DS-XL

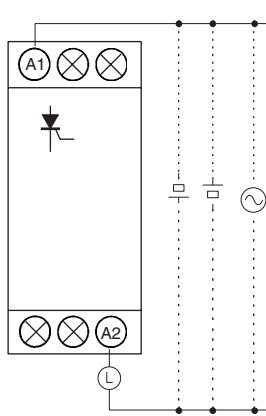

DC supply voltage does not require the designation of polarity.

Installation of Cage Clamp Terminal Models

Tools

A flat-blade screwdriver should be used to install the cables.

Applicable Screwdriver

- Flat-blade, Parallel-tip, 2.5 mm diameter

- Flat-blade, Parallel-tip



- Flat-blade, Flared-tip

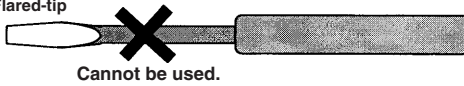

Examples: FACOM AEF.2.5 × 75E
VESSEL No. 9900(-)2.5 × 75
WAGO 210-119
WIHA 260/2.5 × 40

Applicable Wires

Applicable Wire Sizes

0.2 to 1.5 mm², AWG24 to AWG16

Applicable Wire Type

Solid wires, stranded wires, flexible wires, or wires with ferrules can be used.

(See note 1) $1.8 \leq \text{Diameter } D \text{ (mm)} \leq 3.0$ (see note 2)

Conductor diameter d (mm) or length of sides a and b (mm) ≤ 1.6

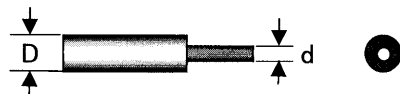

Wires with Ferrules



- Note:**
1. If the overall diameter of the wire is less than 1.8 mm, do not insert the wire past the conductor. Refer to the following diagrams.
 2. If the overall diameter of the wire is over 2.8 mm, it will be difficult to use double wiring.



Wiring

Use wires of the applicable sizes specified above. The length of the exposed conductor should be 6 to 7 mm.

Fig. 1 Exposed Conductor Length

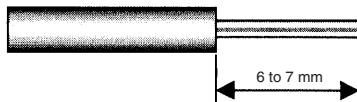

Use the following procedure

1. Insert the specified screwdriver into the release hole locate beside the wire connection hole where the wire is to be inserted.

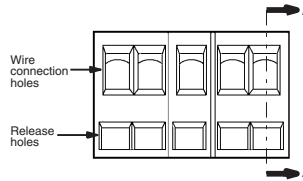

Fig. 2 Wire Connection Holes and Release Holes

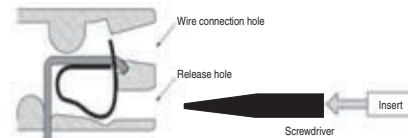
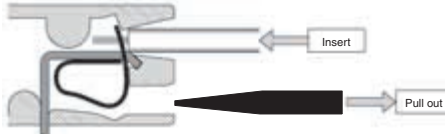

Fig. 3 Section A-A of Fig. 2

2. Insert the exposed conductor into the wire connection hole.



3. Pull out the screwdriver.



Wiring Precautions

Always insert the screwdriver straight into the hole, never at an angle. The clamp spring may bend if the screwdriver is not straight.

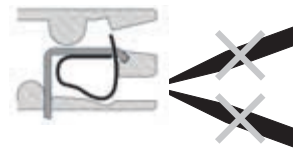

Do not move the screwdriver side to side in the clamp hole. The clamp spring may bend if the screwdriver is moved sideways.



Precautions

■ Setting Changes

— ⚠ WARNING —

Do not change the time scale or operating mode while the Timer is in operation, or malfunction could result.

■ Power Supplies

The H3DS Series has a transformerless power supply system. Touching the input terminal while power is being supplied can cause you to get an electrical shock.

Use the bar terminal for wiring the H3DS. Using a stranded-wire terminal may cause a short-circuit due to a stray wire entering into the Timer.

Both AC and DC power supplies can be connected to the power input terminals without regard to polarity.

A DC power supply can be connected if its ripple factor is 20% or less and the mean voltage is within the rated operating voltage range of the Timer.

Make sure that the voltage is applied within the specified range, or the internal elements of the Timer may be damaged.

Connect the power supply voltage through a relay or switch in a way so that the voltage reaches a fixed value at once. If this is not done, the Timer may not be reset, or a timer error could result.

■ Installation

Several H3DS-XL□ Timers can be mounted together side by side.

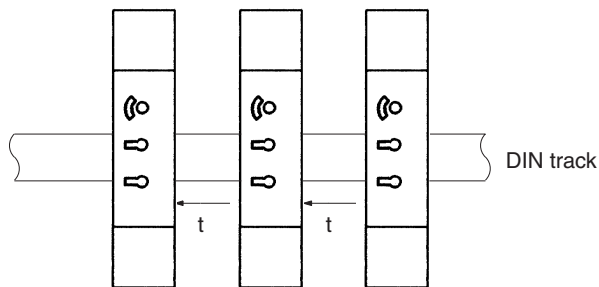

t: Mounting clearance (mm)

■ Precautions for EN61812-1 Conformance

The following conditions must be met so that the built-in timer in the H3DS conforms to EN61812-1:

The output section of the H3DS is provided with basic isolation only. To ensure reinforced isolation required by the EN61812-1, provide supplementary basic isolation on the load side connected to the output.

The H3DS itself is designed according to the following:

- Overvoltage category III
- Pollution degree 2

On the above basis:

Operation parts on the front and bottom: reinforce isolation

- With clearance of 5.5 mm and creepage distance of 5.5 mm at 230 VAC

Output: Basic isolation

- With clearance of 3 mm and creepage distance of 3 mm at 230 VAC

■ Environment

When using the Timer in an area with excess electrical noise, separate the Timer, wiring, and the equipment which generates the input signals as far as possible from the noise sources. Shield the input signal wiring to prevent electrical interference.

Organic solvents (such as paint thinner), as well as very acidic or basic solutions, can damage the outer casing of the Timer.

Do not use the Timer in places where it is exposed to dust, corrosive gas, or direct sunlight.

When storing the Timer, make sure that the ambient temperature and humidity are within the rated values. If the timer has been stored at an ambient temperature of -10°C or below, leave the Timer at room temperature for at least three hours before using the Timer.

■ Voltage Withstand Test

Before carrying out a voltage withstand test between the electrical circuitry and non-current-carrying metal part of the Timer, remove the Timer from the control board (if it's mounted there) or short-circuit the circuitry of the power board. This prevents the internal circuitry of the Timer from damage.

ALL DIMENSIONS SHOWN ARE IN MILLIMETERS.

To convert millimeters into inches, multiply by 0.03937. To convert grams into ounces, multiply by 0.03527.

OMRON**OMRON ELECTRONICS LLC**

One East Commerce Drive
Schaumburg, IL 60173

1-800-55-OMRON**OMRON ON-LINE**Global - <http://www.omron.com>USA - <http://www.omron.com/oei>Canada - <http://www.omron.com/oci>**OMRON CANADA, INC.**

885 Milner Avenue

Scarborough, Ontario M1B 5V8

416-286-6465

Solid-State Two-Wired Timer

H3DS-X

17.5 mm Two-Wired Timer Designed for Track Mounting

- Wide AC/DC power supply range (24-230 VAC/VDC)
- Smart Dial/Selector-Locking Mechanism prevents the dials and selectors on the Timer's front panel from being operated without authorization. (The lock can only be unlocked and locked with an optional pen-type Lock key.)
- Time range of 0.1 second to 120 hours
- Finger-protection terminal block



Ordering Information

Description	Supply voltage	Part number	
		Screw terminal type	Cage clamp type
ON-delay	24 to 230 VAC/VDC (50/60 Hz)	H3DS-XL AC/DC 24-230	H3DS-XLC AC/DC 24-230

Model Number Legend

H3DS -X L □
1 2 3

1. X: Two-wired timer
2. L: Smart lock mechanism
3. None: Screw terminal type
C: Cage clamp type

Accessories (Order Separately)

Description	Part number
Lock key	Y92S-38
Mounting track	50 cm (l) x 7.3 mm (t) PFP-50N
	1 m (l) x 7.3 mm (t) PFP-100N
	1 m (l) x 16 mm (t) PFP-100N2
End plate	PFP-M
Spacer	PFP-S

Specifications

■ General

Item	H3DS-X
Operating mode	ON-delay
Operating/Reset method	Time-limit operation/self-resetting
Output type	SCR output
External connections	Screw terminal, cage clamp
Terminal block	Screw terminal type: Clamps two 2.5-mm ² max. bar terminals without sleeves. Cage clamp type: Clamps two 1.5-mm ² max. bar terminals without sleeves.
Terminal screw tightening torque	0.98 N • m max.
Output type	(Star operation circuit) Relay: SPST-NO (Delta operation circuit) Relay: SPST-NO
Mounting method	DIN track mounting (see note)
Attachment	Nameplate label
Approved standards	UL508, CSA C22.2 No.14 Conforms to EN61812-1, IEC60664-1 (VDE0110) 4 kV/2, VDE0106/P100

Note: Can be mounted to 35-mm DIN Track with a plate thickness of 1 to 2.5 mm.

■ Time Ranges

Time scale	Star operation time ranges
0.1 s	0.1 to 1.2 s
1 s	1 to 12 s
0.1 m	0.1 to 1.2 min
1 m	1 to 12 min
0.1 h	0.1 to 1.2 h
1 h	1 to 12 h
10 h	10 to 120 h

Note: When the time setting dial is set to "0" for any time scale, the output will operate instantaneously.

■ Ratings

Rated supply voltage (see note)	24 to 230 VAC/VDC (50/60 Hz)
Operating voltage range	85% to 110% of rated supply voltage
Power reset	Minimum power-off time: 0.1 s
Reset voltage	1.0 VAC/VDC max.
Reset current	5 mA max.
Power consumption	5 mA max.
Control output	SCR output: 5 mA to 0.7A
Ambient temperature	Operating: -10°C to 55°C (14°F to 131°F) with no icing Storage: -25°C to 65°C (-13°F to 145°F) with no icing
Ambient humidity	Operating: 35% to 85%

Note: DC ripple rate: 20% max.

■ Characteristics

Accuracy of operating time	±1% max. of FS (±1% ±10 ms max. at 1.2 s range)
Setting error	±10% ±50 ms max. of FS
Reset time	0.1 s max.
Influence of voltage	±0.5% max. of FS (±0.5% ±10 ms max. at 1.2 s range)
Influence of temperature	±2% max. of FS (±2% ±10 ms max. at 1.2 s range)
Insulation resistance	100 MΩ min. at 500 VDC
Dielectric strength	Between current-carrying metal parts and exposed non-current-carrying metal parts: 2,000 VAC for 1 min.
Impulse withstand voltage	3 kV (between power supply terminals) 4.5 kV (between current-carrying metal parts and exposed non-current-carrying metal parts)
Noise immunity	Square-wave noise generated by noise simulator (pulse width: 100 ns/1 μs, 1-ns rise) ±1.5 kV (between power supply terminals)
Static immunity	Malfunction: 4 kV Destruction: 8 kV
Vibration resistance	Malfunction: 0.5 mm single amplitude at 10 to 55 Hz Destruction: 0.75 mm single amplitude at 10 to 55 Hz
Shock resistance	Malfunction: 200 m/s ² , 3 times each in 6 directions Destruction: 300 m/s ² , 3 times each in 6 directions
EMC	(EMI) Emission Enclosure: EN55011 Group 1 class B Emission AC Mains: EN55011 Group 1 class B (EMS) Immunity ESD: EN61000-4-2: 6 kV contact discharge (level 3) 8 kV air discharge (level 3) Immunity RF-interference from AM Radio Waves: EN61000-4-3: 10 V/m (80 MHz to 1 GHz) (level 3) Immunity Burst: EN61000-4-4: 2 kV power port and output port (level 3) 1 kV control port with capacitive clamp (level 3) Immunity Surge: EN61000-4-5: 2 kV common mode (level 3) 1 kV differential mode (level 3)
Case color	Light gray (5Y7/1)
Degree of protection	IP30 (IP20 for terminal block)
Weight	Approx. 70 g

Nomenclature

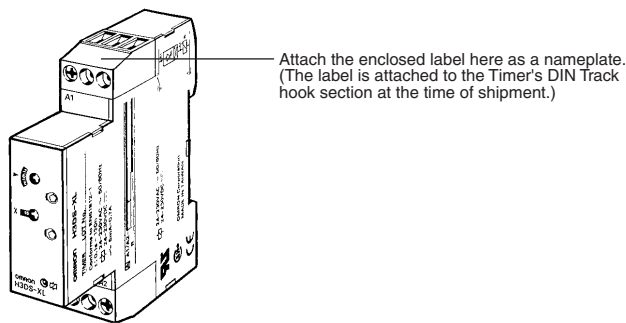
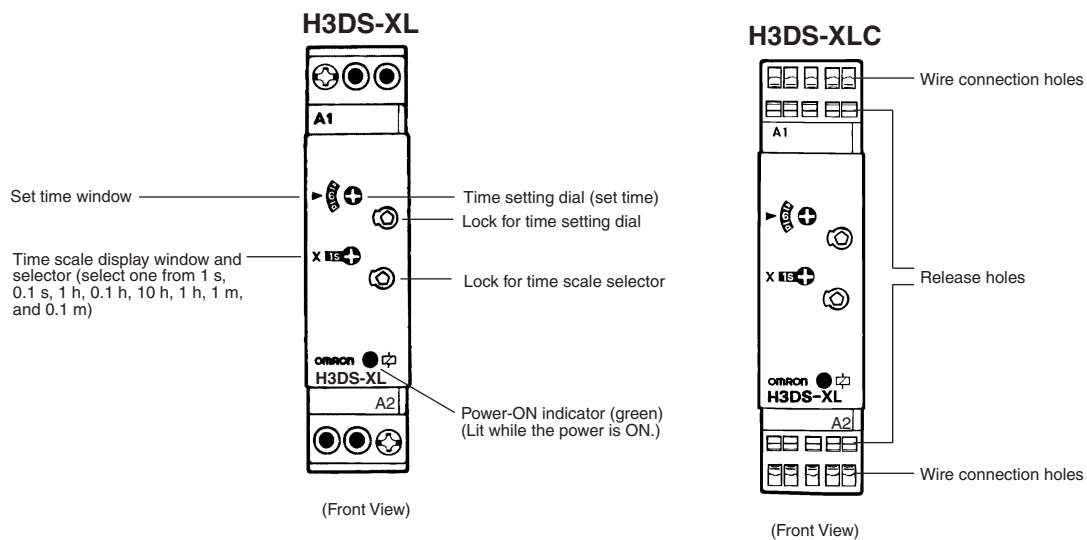

Operation

■ Block Diagram

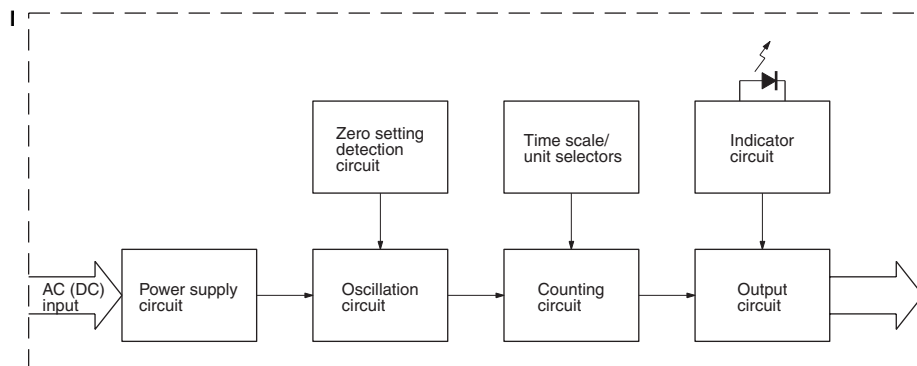

■ I/O Functions

Inputs	---	
Outputs	Control output	Outputs are turned On when the preset value is reached.

■ Basic Operation
Selector Settings

The selectors can be turned clockwise and counterclockwise to select the desired time scale or operating mode.

Each selector has a snap mechanism that secures the selector at a given position. Set the selector at a position where it is secured. Do not set it midway between two secure positions, or a malfunction could result from improper setting.

Selection of Time Scale

To select the time scale, turn the time scale selector, and the time scales will appear (in the time scale display window on the left of the selector) in the order shown here:

1 s, 0.1 s, 1 h, 0.1 h, 10 h, 1 h, 1 m, 0.1 m.

Note: The time scale “1h” appears twice. Both instances indicate exactly the same time

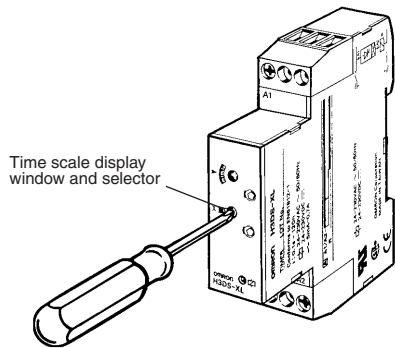

Locking/Unlocking Selectors and the Time Setting Dial

The time setting dial and time scale selector can be locked using the Y92S-38 Lock Key, a special pen type tool that is sold separately. To lock the dial or selectors, insert the Lock Key in the keyhole to the lower right of the dial or selector and turn it clockwise until the dial or selector is completely covered with the red cover. To unlock, turn the Lock Key in the opposite direction.

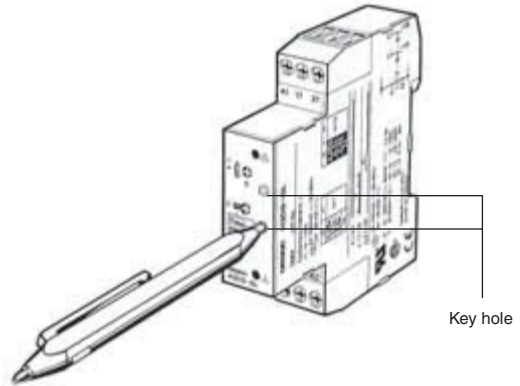

■ Timing Charts

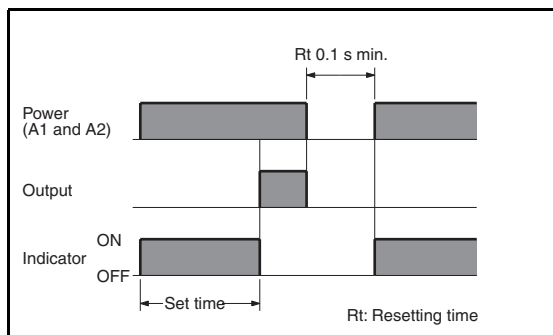

Dimensions

Unit: mm (inch)

■ H3DS-XL

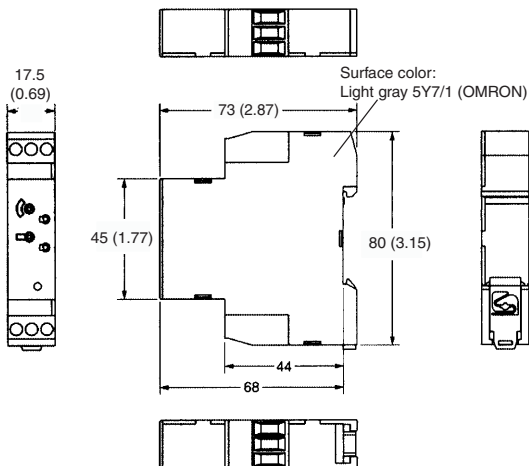
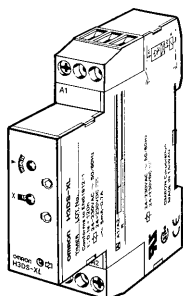

■ H3DS-XLC

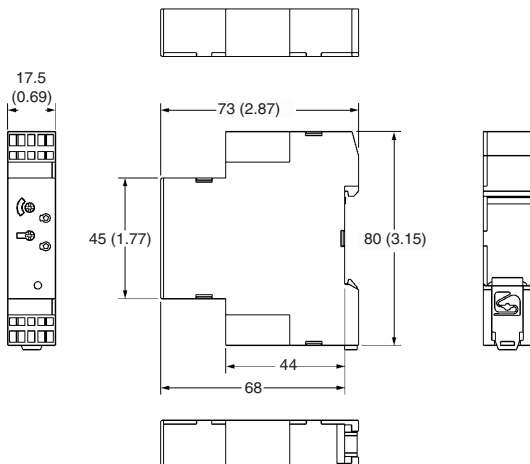
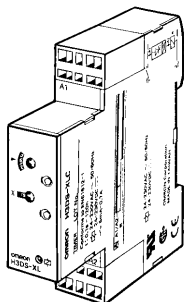

Accessories (Order Separately)

■ Lock Key Y92S-38

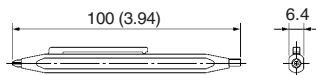
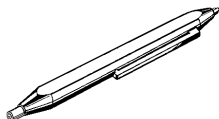

Unit: mm (inch)

■ Mounting Track

PFP-100N, PFP-50N

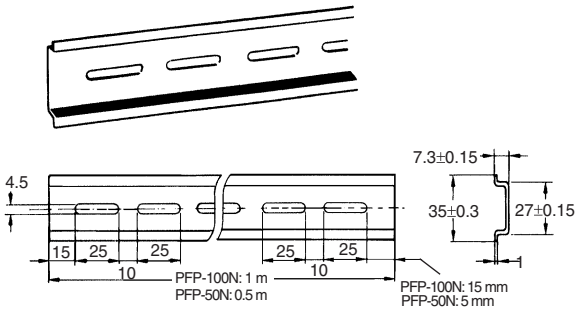

PFP-100N2

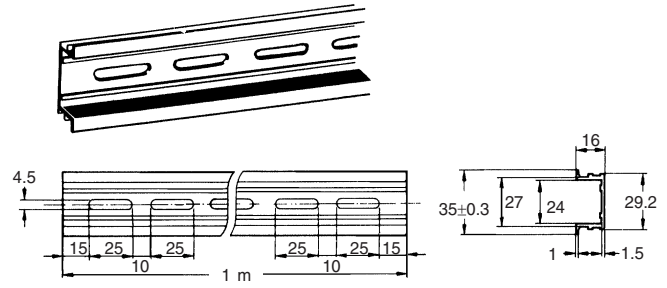

■ End Plate

PFP-M

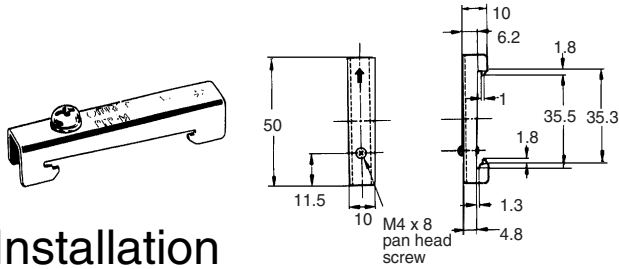

■ Spacer

PFP-S

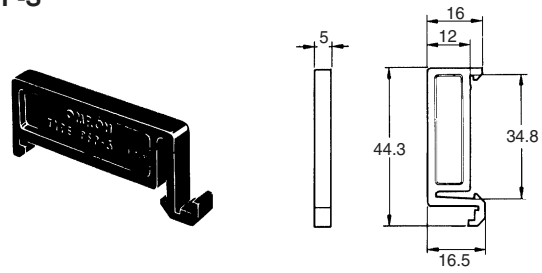

Installation

■ Terminal Arrangement

H3DS-XLC

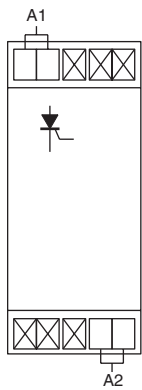

H3DS-XL

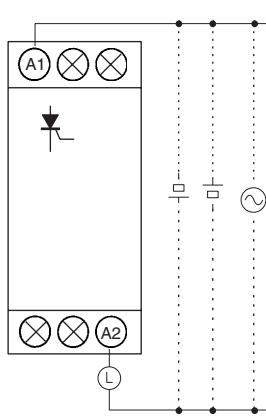

DC supply voltage does not require the designation of polarity.

Installation of Cage Clamp Terminal Models

Tools

A flat-blade screwdriver should be used to install the cables.

Applicable Screwdriver

- Flat-blade, Parallel-tip, 2.5 mm diameter

- Flat-blade, Parallel-tip



- Flat-blade, Flared-tip

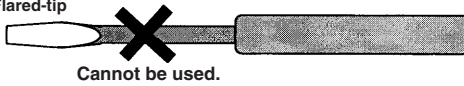

Examples: FACOM AEF.2.5 × 75E
VESSEL No. 9900(-)2.5 × 75
WAGO 210-119
WIHA 260/2.5 × 40

Applicable Wires

Applicable Wire Sizes

0.2 to 1.5 mm², AWG24 to AWG16

Applicable Wire Type

Solid wires, stranded wires, flexible wires, or wires with ferrules can be used.

(See note 1) $1.8 \leq \text{Diameter } D \text{ (mm)} \leq 3.0$ (see note 2)

Conductor diameter d (mm) or length of sides a and b (mm) ≤ 1.6

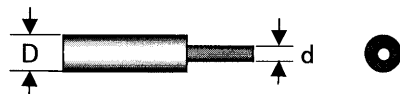

Wires with Ferrules



- Note:**
1. If the overall diameter of the wire is less than 1.8 mm, do not insert the wire past the conductor. Refer to the following diagrams.
 2. If the overall diameter of the wire is over 2.8 mm, it will be difficult to use double wiring.



Wiring

Use wires of the applicable sizes specified above. The length of the exposed conductor should be 6 to 7 mm.

Fig. 1 Exposed Conductor Length

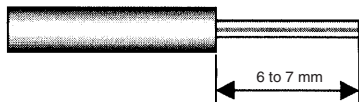

Use the following procedure

1. Insert the specified screwdriver into the release hole locate beside the wire connection hole where the wire is to be inserted.

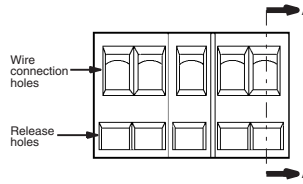

Fig. 2 Wire Connection Holes and Release Holes

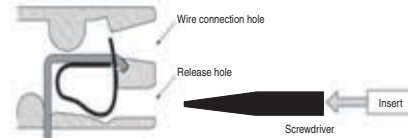

Fig. 3 Section A-A of Fig. 2



2. Insert the exposed conductor into the wire connection hole.



3. Pull out the screwdriver.

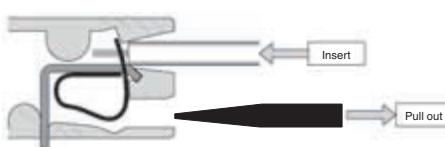

Wiring Precautions

Always insert the screwdriver straight into the hole, never at an angle. The clamp spring may bend if the screwdriver is not straight.

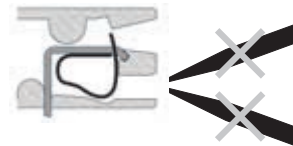

Do not move the screwdriver side to side in the clamp hole. The clamp spring may bend if the screwdriver is moved sideways.



Precautions

■ Setting Changes

— ⚠ WARNING —

Do not change the time scale or operating mode while the Timer is in operation, or malfunction could result.

■ Power Supplies

The H3DS Series has a transformerless power supply system. Touching the input terminal while power is being supplied can cause you to get an electrical shock.

Use the bar terminal for wiring the H3DS. Using a stranded-wire terminal may cause a short-circuit due to a stray wire entering into the Timer.

Both AC and DC power supplies can be connected to the power input terminals without regard to polarity.

A DC power supply can be connected if its ripple factor is 20% or less and the mean voltage is within the rated operating voltage range of the Timer.

Make sure that the voltage is applied within the specified range, or the internal elements of the Timer may be damaged.

Connect the power supply voltage through a relay or switch in a way so that the voltage reaches a fixed value at once. If this is not done, the Timer may not be reset, or a timer error could result.

■ Installation

Several H3DS-XL□ Timers can be mounted together side by side.

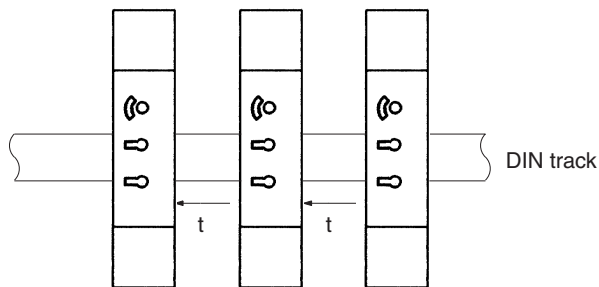

t: Mounting clearance (mm)

■ Precautions for EN61812-1 Conformance

The following conditions must be met so that the built-in timer in the H3DS conforms to EN61812-1:

The output section of the H3DS is provided with basic isolation only. To ensure reinforced isolation required by the EN61812-1, provide supplementary basic isolation on the load side connected to the output.

The H3DS itself is designed according to the following:

- Overvoltage category III
- Pollution degree 2

On the above basis:

Operation parts on the front and bottom: reinforce isolation

- With clearance of 5.5 mm and creepage distance of 5.5 mm at 230 VAC

Output: Basic isolation

- With clearance of 3 mm and creepage distance of 3 mm at 230 VAC

■ Environment

When using the Timer in an area with excess electrical noise, separate the Timer, wiring, and the equipment which generates the input signals as far as possible from the noise sources. Shield the input signal wiring to prevent electrical interference.

Organic solvents (such as paint thinner), as well as very acidic or basic solutions, can damage the outer casing of the Timer.

Do not use the Timer in places where it is exposed to dust, corrosive gas, or direct sunlight.

When storing the Timer, make sure that the ambient temperature and humidity are within the rated values. If the timer has been stored at an ambient temperature of -10°C or below, leave the Timer at room temperature for at least three hours before using the Timer.

■ Voltage Withstand Test

Before carrying out a voltage withstand test between the electrical circuitry and non-current-carrying metal part of the Timer, remove the Timer from the control board (if it's mounted there) or short-circuit the circuitry of the power board. This prevents the internal circuitry of the Timer from damage.

ALL DIMENSIONS SHOWN ARE IN MILLIMETERS.

To convert millimeters into inches, multiply by 0.03937. To convert grams into ounces, multiply by 0.03527.

OMRON**OMRON ELECTRONICS LLC**

One East Commerce Drive
Schaumburg, IL 60173

1-800-55-OMRON**OMRON ON-LINE**

Global - <http://www.omron.com>
USA - <http://www.omron.com/oei>
Canada - <http://www.omron.com/oci>

OMRON CANADA, INC.

885 Milner Avenue
Scarborough, Ontario M1B 5V8

416-286-6465